



FLOW TEMP. CONTROLLER 2 (Cased) PAC-IF031B-E

INSTALLATION MANUAL

FOR INSTALLER

For safe and correct use, read this manual thoroughly before installing the FTC2 unit.

OPERATION MANUAL

FOR USER

For safe and correct use, please read this operation manual thoroughly before operating the air-conditioner unit.

English

Contents

1. Safety precautions.....	2	7. Before test run.....	21
2. Installing the FTC2 unit.....	3	8. Remote controller operation.....	22
3. System.....	4	9. Initial setting by remote controller.....	31
4. Electrical work.....	7	10. Definition of analog signal by remote controller.....	33
5. Switch setting of FTC2.....	12	11. Troubleshooting.....	34
6. Operation setting.....	14	Local application factors.....	35

“FTC2” is the abbreviation of “Flow Temperature Controller 2”, which is described as “FTC2” in this manual.

1. Safety precautions

- ▶ Before installing the FTC2 unit, make sure you read all the “Safety precautions”.
- ▶ Please report to your supply authority or obtain their consent before connecting this equipment to the power supply system.

⚠ Warning:
Precautions that must be observed to prevent injuries or death.

⚠ Caution:
Precautions that must be observed to prevent damages to the unit.

- ⚠ Warning:**
- The unit must not be installed by the user. Ask an installer or an authorized technician to install the unit. If the unit is installed improperly, electric shock, or fire may be caused.
 - For installation work, follow the instructions in the Installation Manual and use tools and pipe components specifically made for use with refrigerant specified in the outdoor unit installation manual.
 - The unit must be installed according to the instructions in order to minimize the risk of damages by earthquakes, typhoons, or strong winds. Improperly installed unit may fall down and cause damages or injuries.
 - The unit must be securely installed on a structure that can sustain its weight. If the unit is mounted on an unstable structure, it may fall down and cause damages or injuries.
 - All electrical work must be performed by a qualified technician according to local regulations and the instructions given in this manual. The unit must be powered by dedicated power lines and the correct voltage and circuit breakers must be used. Power lines with insufficient capacity or incorrect electrical work may result in electric shock or fire.

After installation, perform the test run to ensure normal operation. Then explain your customer the “Safety Precautions,” use, and maintenance of the unit based on the information in the Operation Manual provided by local application manufacture. Both the Installation Manual and the Operation Manual must be given to the user. These manuals must always be kept by the actual users.

⚡ :Indicates a part which must be grounded.

⚠ Warning:
Carefully read the labels attached to the unit.

- Only the specified cables can be used for wiring. Connections must be made securely without tension on the terminals. If cables are connected or installed improperly, it may result in overheating or fire.
- Terminal block cover panel of the unit must be firmly fixed. If the cover panel is mounted improperly, dust and moisture may enter the unit, and it may cause electric shock or fire.
- Make sure to use accessories authorized by Mitsubishi Electric and ask an installer or an authorized technician to install them. If accessories are improperly installed, it may cause electric shock, or fire.
- Do not remodel the unit. Consult an installer for repairs. If alterations or repairs are not performed correctly, it may cause electric shock or fire.
- The user should never attempt to repair the unit or transfer it to another location. If the unit is installed improperly, it may cause electric shock or fire. If the FTC2 unit needs to be repaired or moved, ask an installer or an authorized technician.

1.1. Before installation (Environment)

- ⚠ Caution:**
- Do not install the FTC2 unit in outdoor location as it is designed for indoor installation only. Otherwise electric shock or breakdown may be caused by water drop, wind or dust.
 - Do not use the unit in an unusual environment. If the FTC2 unit is installed or exposed to steam, volatile oil (including machine oil), or sulfuric gas, or exposed to briny air, the internal parts can be damaged.
 - Do not install the unit where combustible gases may leak, be produced, flow, or accumulate. If combustible gas accumulates around the unit, it may cause fire or explosion.

- When installing the unit in a hospital or in a building where communications equipment are installed, you may need to take measure to noise and electronic interference. Inverters, home appliances, high-frequency medical equipment, and radio communications equipment can cause the FTC2 unit to malfunction or to breakdown. At the same time, the noise and electric interference from the FTC2 unit may disturb the proper operation of medical equipment, and communications equipment.

1.2. Before installation or relocation

- ⚠ Caution:**
- Be fully careful when moving the units. Do not hold the packaging bands. Wear protective gloves to unpack and to move it, in order to avoid your hands be injured by parts.

- Be sure to safely dispose of the packaging materials. Packaging materials, such as nails and other metal or wooden parts may cause injuries.
- Do not wash the FTC2 unit. You may receive an electric shock.

1.3. Before electric work

- ⚠ Caution:**
- Be sure to install a circuit breaker. If it is not installed, there may be a risk to get an electric shock.
 - For the power lines, use standard cables of sufficient capacity. Otherwise, it may cause a short circuit, overheating, or fire.
 - When installing the power lines, do not apply tension to the cables. The cables may be cut or overheated resulting in a fire.

- Make sure to ground the unit. Do not connect the ground wire to gas or water pipes, lightning rods, or telephone grounding lines. If the unit is not properly grounded, there may be a risk to get an electric shock.
- Make sure to use circuit breakers (ground fault interrupter, isolating switch (+B fuse), and molded case circuit breaker) with the specified capacity. If the circuit breaker capacity is larger than the specified capacity, breakdown or fire may result.

1.4. Before starting the test run

- ⚠ Caution:**
- Turn on the main power switch of the outdoor unit more than 12 hours before starting operation. Starting operation immediately after turning on the power switch can severely damage the internal parts. Keep the main power switch turned on during the operation period.

- Before starting operation, check that all protective parts are correctly installed. Make sure not to get injured by touching high voltage parts.
- Do not touch any switch with wet hands. There may be a risk to get an electric shock.
- After stopping operation, make sure to wait at least 5 minutes before turning off the main power. Otherwise, it may cause breakdown.

1.5. Electric booster and Immersion heaters

- ⚠ Warning:**
- FTC2 has signal outputs for booster heaters however it can not isolate power to them in the event of overheating. All electrical heaters used on the water circuit must have

- a) Self cut-out mechanism to prevent overheating OR
- b) A thermostat to prevent overheating

2. Installing the FTC2 unit

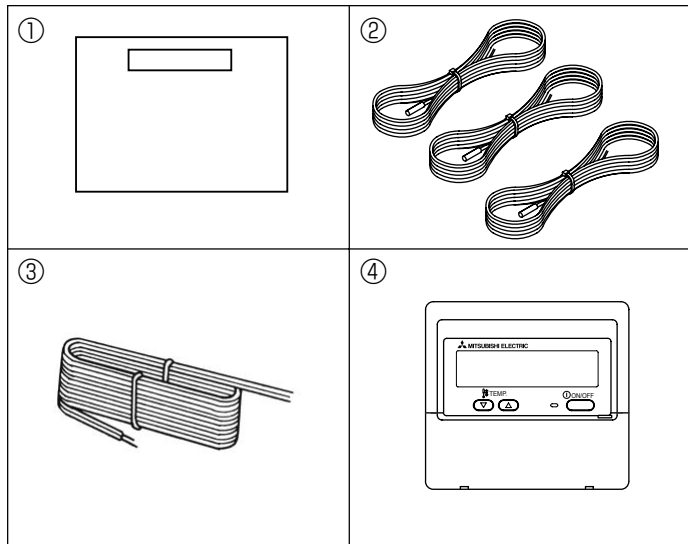

Fig. 2-1

2.1. Check the parts (Fig. 2-1)

The FTC2 unit should be supplied with the following parts.

	Part Name	Q'ty
①	FTC2 unit	1
②	Thermistor	3
③	Remote controller cable (5m)	1
④	Remote controller	1

2.2. Choosing the FTC2 unit installation location

- Do not install the FTC2 unit in outdoor location as it is designed for indoor installation only. (The FTC2 circuit board and casing are not waterproof.)
- Avoid locations where the unit is exposed to direct sunlight or other sources of heat.
- Select a location where easy wiring access to the power source is available.
- Avoid locations where combustible gases may leak, be produced, flow, or accumulate.
- Select a level location that can bear the weight and vibration of the unit.
- Avoid locations where the unit is exposed to oil, steam, or sulfuric gas.
- Do not install in location that is hot or humid for long periods of time.

2.3. Installing the FTC2 unit (Fig. 2-2, Photo. 2-1)

1. Remove 2 screws from FTC2 unit and remove the cover.
2. Install the 4 screws (locally supplied) in 4 holes.

- Ⓐ Screw Ⓑ Cover
Ⓒ Hole for installation

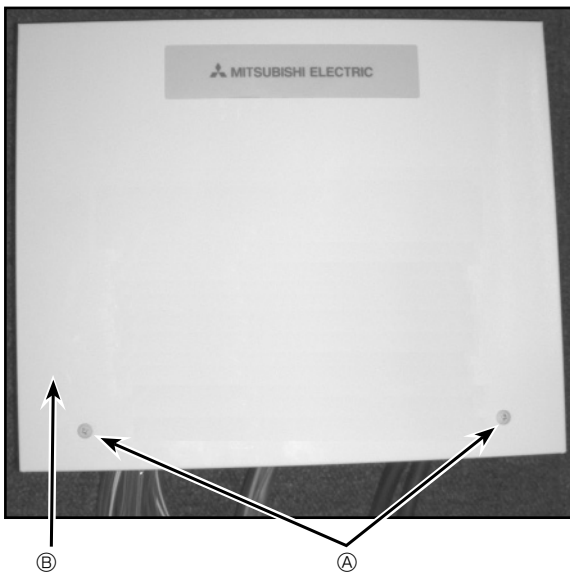

Photo. 2-1

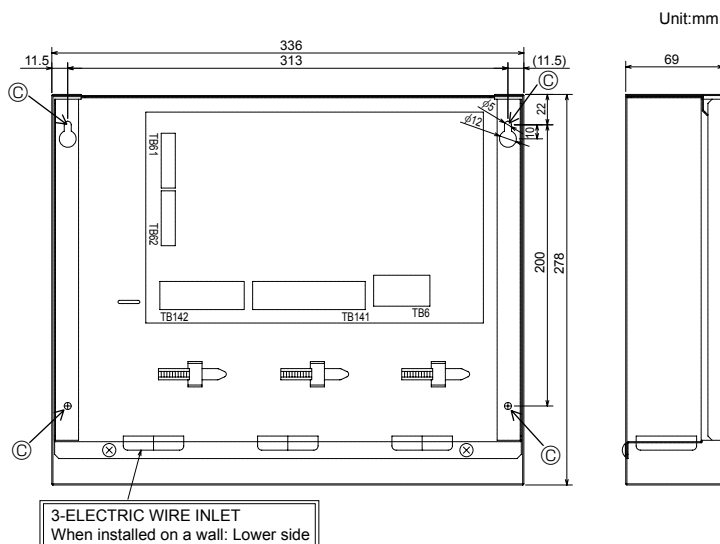

Fig. 2-2

3. System

The FTC2 is designed for use with a number of heat pump systems. Please refer to the following table to find the relevant installation information for your system.

First step (Electrical work)

Power supplies (Outdoor only)

Remote controller or external input

Mode select	Temp. setting	System diagram	Power supplies	Operation mode input
Remote controller (PAR-W21MAA)	Remote controller (PAR-W21MAA)		Outdoor unit only → 4.1 4.1.1	Remote controller only → 4.2
Local controller (External input)	Remote controller (PAR-W21MAA)		Outdoor unit only → 4.1 4.1.1	Remote controller and external input → 4.2 4.3 4.3.1
Local controller (External input)	Analog input		Outdoor unit only → 4.1 4.1.1	External input and analog input → 4.3 4.3.1 4.3.2

3. System

Second step (thermistor setting)

Outdoor type (SPLIT type / PACKAGED type)

Domestic Hot Water (DHW) tank

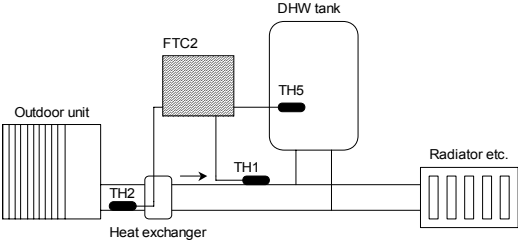
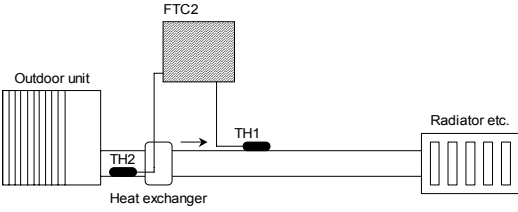
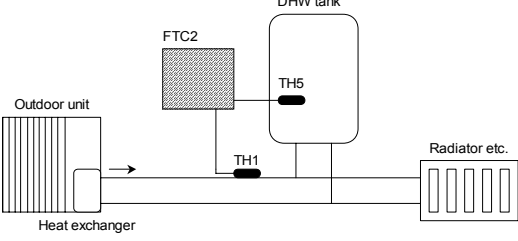
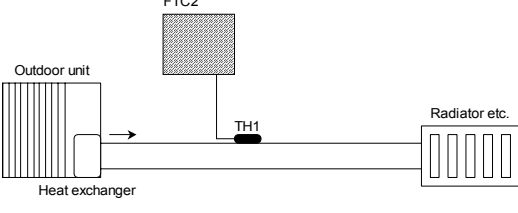
Outdoor unit type	DHW tank	System diagram	Thermistor (TH1,TH2,TH5)
SPLIT type	○ (Present)		TH1: actual flow water temp. TH2: refrigerant pipe temp. TH5: actual DHW tank temp. → 4.4
	✗ (Absent)		TH1: actual flow water temp. TH2: refrigerant pipe temp. TH5: — → 4.4
PACKAGED type	○ (Present)		TH1: actual flow water temp. TH2: — TH5: actual DHW tank temp. → 4.4
	✗ (Absent)		TH1: actual flow water temp. TH2: — TH5: — → 4.4

3. System

Third step (Heater setting)

Immersion heater

Booster heater position

Immersion heater	Booster heater position	System diagram	Output signal
<p>✗ (Absent)</p>	<p>both DHW and Heating</p>		<p>Booster heater only → 4.5</p>
<p>○ (Present)</p>	<p>both DHW and Heating</p>		<p>Booster heater and Immersion heater → 4.5</p>
<p>✗ (Absent)</p>	<p>Heating only</p>		<p>Booster heater only → 4.5</p>
<p>○ (Present)</p>	<p>Heating only</p>		<p>Booster heater and Immersion heater → 4.5</p>

4. Electrical work

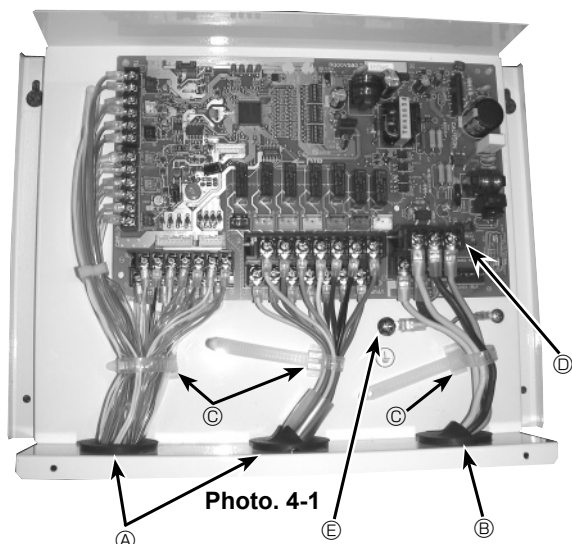

4.1. FTC2 (Photo. 4-1)

1. Remove the cover.
 2. Wire the power cable and control cable separately through the respective wiring inlets given in the photo.
- Make sure to put screws tightly.
 - Ⓐ Inlet for control cable
 - Ⓑ Inlet for power cable
 - Ⓒ Clamp
 - Ⓓ FTC2 / Outdoor unit connecting terminals
 - Ⓔ Earth terminal

4.1.1. FTC2 unit power supplied from outdoor unit

The outdoor unit must be powered properly. (Details are shown in its installation manual.)

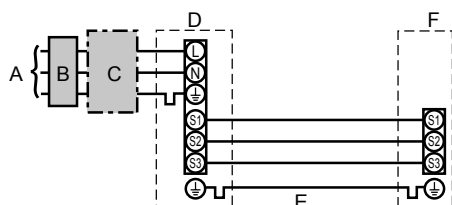

- A Outdoor unit power supply
- B Earth leakage breaker
- C Wiring circuit breaker or isolating switch
- D Outdoor unit
- E FTC2 unit/outdoor unit connecting cables
- F FTC2 unit

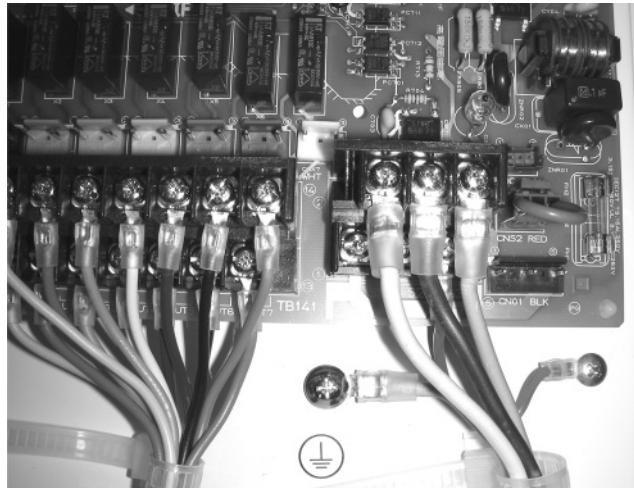
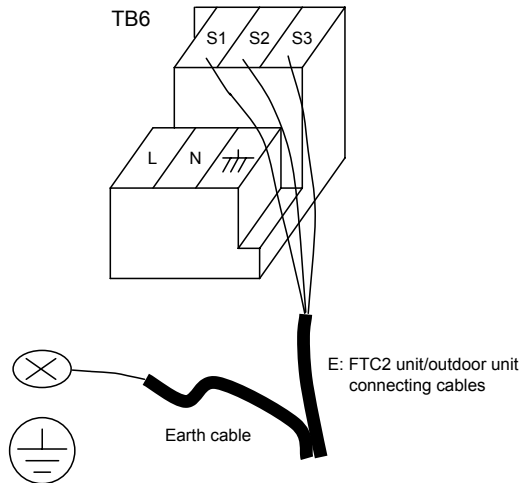

Photo. 4-2



FTC2 unit model		PAC-IF031B-E	
Wiring Wire No. x size (mm ²)	FTC2 unit-Outdoor unit	*1	3 × 1.5 (polar)
	FTC2 unit-Outdoor unit earth	*1	1 × Min.1.5
Circuit rating	FTC2 unit-Outdoor unit S1-S2	*2	AC 230 V
	FTC2 unit-Outdoor unit S2-S3	*2	DC24 V

*1. Max. 80 m

*2. The figures are NOT always against the ground.

S3 terminal has DC 24 V against S2 terminal. However between S3 and S1, these terminals are not electrically insulated by the transformer or other device.

Notes: 1. Wiring size must comply with the applicable local and national codes.

2. Power supply cables and FTC2 unit/outdoor unit connecting cables shall not be lighter than polychloroprene sheathed flexible cable. (Design 60245 IEC 57)

3. Install an earth wire longer than other cables.

4. Electrical work

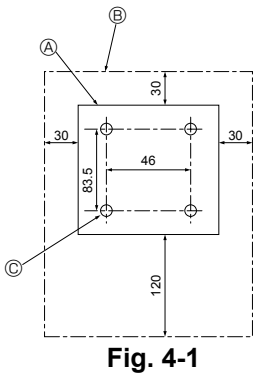

Fig. 4-1

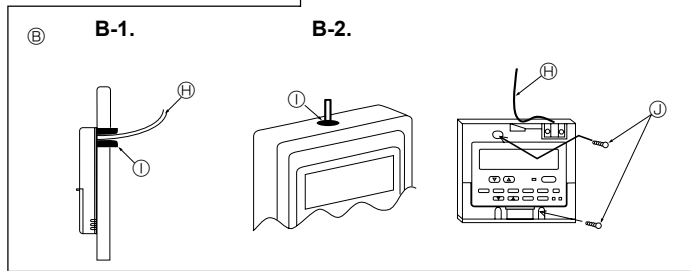

Fig. 4-2

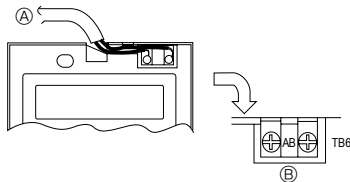

Fig. 4-3

4.2. Connecting the wired remote controller

4.2.1. Connecting the wired remote controller cable to FTC2

Connect the wired remote controller cable to 5 and 6 on the terminal block (TB62) on the FTC2 controller. (Photo. 4-3)

Wiring wire No. × size (mm²) : 2×0.3 (Non-polar)

The 5m wire is attached as an accessory. Max. 500 m

Wiring size must comply with the applicable local and national codes.

Circuit rating: DC12V

Circuit rating is NOT always against the ground.

4.2.2. For wired remote controller

1) Installing procedures

(1) Select an installing position for the remote controller. (Fig. 4-1)

► Procure the following parts locally:

- 2 piece switch box
- Thin copper conduit tube
- Lock nuts and bushings

[Fig. 4-1]

- Ⓐ Remote controller profile
 - Ⓑ Required clearances surrounding the remote controller
 - Ⓒ Installation pitch
- (2) Seal the service entrance for the remote controller cable with putty to prevent possible invasion of dew drops, water, cockroaches or insects. (Fig. 4-2)

Ⓐ For installation in the switch box

Ⓑ For direct installation on the wall, select one of the followings:

- Prepare a hole through the wall to pass the remote controller cable (in order to take out the remote controller cable from the back), then seal the hole with putty.
- Take out the remote controller cable through the cut-out upper case, then seal the cut-out notch with putty.

B-1. To lead the remote controller cable from the back of the controller

B-2. To take out the remote controller cable through the upper portion

[Fig. 4-2]

- Ⓒ Wall
- Ⓓ Conduit
- Ⓔ Lock nut
- Ⓕ Bushing
- Ⓖ Switch box
- Ⓗ Remote controller cable
- Ⓘ Seal with putty
- Ⓣ Wood screw

2) Connecting procedures (Fig. 4-3)

① Connect the remote controller cable to the terminal block.

- Ⓐ To TB62 No.5 and 6 on the FTC2 unit
- Ⓑ TB6 (No polarity)

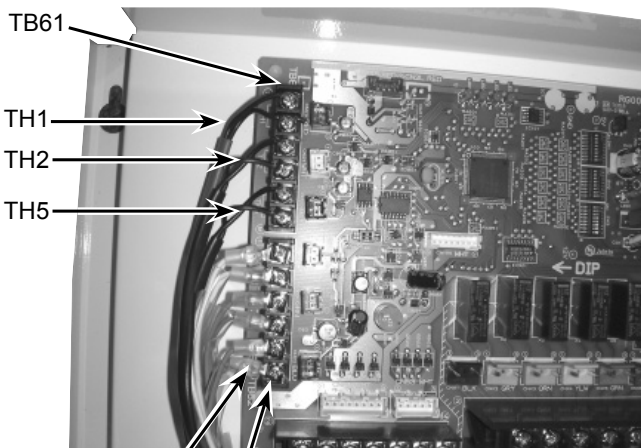

Photo.4-3

TB62
Wired remote controller cable

4. Electrical work

4.3. Connecting external input

FTC2 can be operated by following external input.

4.3.1. EXTERNAL INPUT (Contact signal)

Terminal block		OFF (Open)	ON (Short)	Remark
TB142 1-2	(IN1)	OFF	Emergency	
TB142 3-4	(IN2)	OFF	Legionella prevention *3	
TB142 5-6	(IN3)	Normal	Comp. OFF	SW3-6 = OFF
		Comp. OFF	Normal	SW3-6 = ON
TB142 7-8	(IN4)	OFF	Cooling	
TB142 10-11	(COM-IN5)	OFF	Heating	
TB142 10-12	(COM-IN6)	OFF	Heating ECO *1	
TB142 10-13	(COM-IN7)	OFF	Hot Water *4	
TB142 10-14	(COM-IN8)	OFF	Anti-Freeze	
TB62 1-2	(Ana. IN1)	Normal operation	Comp. OFF *2	SW3-4 = OFF
		Comp. OFF *2	Normal operation	SW3-4 = ON

*1 Heating ECO mode sets the set temperature depending on the outdoor temperature.

*2 In case of Cooling, Heating, Heating ECO and Anti-Freeze.

*3 Input signal: Pulse

Pulse specifications: ON (short)

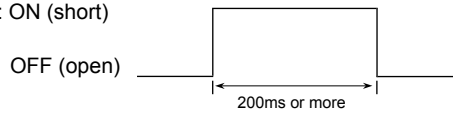

*4 When SW1-8 is OFF, the mode is switched into Auto hot water.

Input signal: Pulse

Pulse specifications: ON (short)

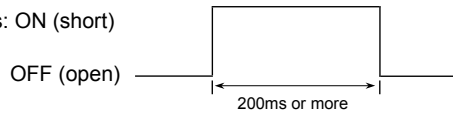

When SW1-8 is ON, the mode is switched into Hot water.

4.3.2. EXTERNAL INPUT (analog signal) 4-20mA / 1-5V / 0-10V

Connect the transmission cables to No. 3 and 4 on the terminal block (TB62).

No. 3 on the terminal block (TB62) : Plus side

No. 4 on the terminal block (TB62) : Minus side (Reference side)

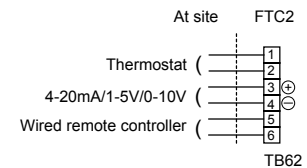

4-20mA / 1-5V / 0-10V setting

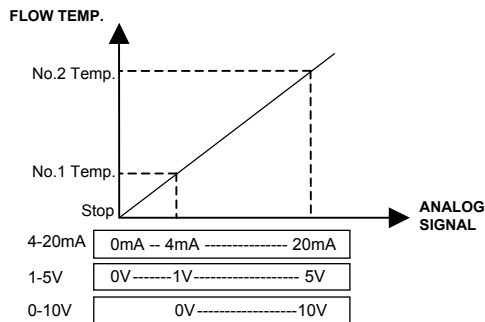

Refer to the section 10 for details about No.1, 2 Temp.

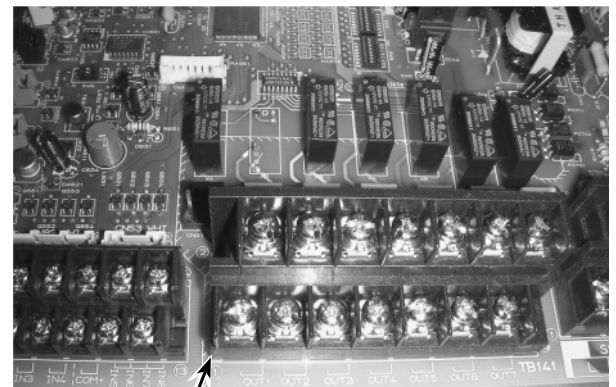

TB141

Photo.4-4

Caution:

The external input signals are separated by basic insulation from power supply for the unit.

The external input signals should be separated by supplementary insulation from where user may touch in case that it is installed where user may touch.

Connect the terminals by using the ring terminals and also insulate the cables of adjoining terminals when wiring to terminal block.

4.3.3. Wiring specification of External input

Locally supplied parts

Item	Name	Model and specifications
External input function	External input signal wire	Use sheathed vinyl coated cord or cable. Max. 10m Wire type :CV, CVS or equivalent Wire size :Stranded wire 0.5mm ² to 1.25mm ² Solid wire : ϕ 0.65mm to ϕ 1.2mm
	Switch	Non-voltage "a" contact signals Remote switch : minimum applicable load DC 12V, 1mA

4. Electrical work

4.4. Connecting thermistor cable

Connect the thermistor ② for the FTC2 controller.

4.4.1. Connecting the actual flow water temp. thermistor (TH1)

Connect the thermistor for the actual flow water temp. to 1 and 2 on the terminal block (TB61) on the FTC2 controller.

When the thermistor cables are too long, cut them at the appropriate length.

Do not bind them in the FTC2 unit.

<Thermistor position>

Put TH1 on **water** piping (water **outlet** side) after booster heater.

Note: Be sure to attach the TH1 where it detects Flow temp. (Water outlet side) correctly.

4.4.2. Connecting the pipe temp. thermistor (TH2)

Connect the thermistor for the refrigerant pipe temp. to 3 and 4 on the terminal block (TB61) on the FTC2 controller.

For packaged Outdoor unit : It is NOT necessary to connect TH2.

For split Outdoor unit : Connect TH2.

When the thermistor cables supplied with FTC2 are too long, cut them to the appropriate length.

Do not bind them in the FTC2 unit.

<Thermistor position>

Put the TH2 on **refrigerant** piping (**Liquid** side).

It is better to protect the thermistor with heat insulating materials not to be affected by the ambient temperature.

Note: Be sure to attach the TH2 where it detects Refrigerant piping temp. (Liquid side) correctly.

4.4.3. Connecting the actual DHW tank thermistor (TH5)

Connect the thermistor for the actual DHW tank temp. to 5 and 6 on the terminal block (TB61) on the FTC2 controller.

When the thermistor cables supplied with the FTC2 are too long, cut them to the appropriate length.

Do not bind them in the FTC2 unit.

<Thermistor position>

Put the TH5 on the DHW tank. It should be positioned directly onto the lower half of the external surface of the tank.

Caution:

Do not route the thermistor cables together with power cables.

The sensor part of the thermistor should be installed where user must not touch. (It is separated by the supplementary insulation from where user may touch.)

4.4.4. Thermistor position and necessity

For packaged type Outdoor unit: It is NOT necessary to connect TH2.

For split type Outdoor unit: Connect TH2

<Thermistor position and necessity>

Outdoor Type	DHW tank	TH1	TH2	TH5
PACKAGED type	Present	O	X	O
	Absent	O	X	X
SPLIT type	Present	O	O	O
	Absent	O	O	X

O: Necessary. Connect the thermistor.

X: Not necessary. The thermistor is not required, do not connect.

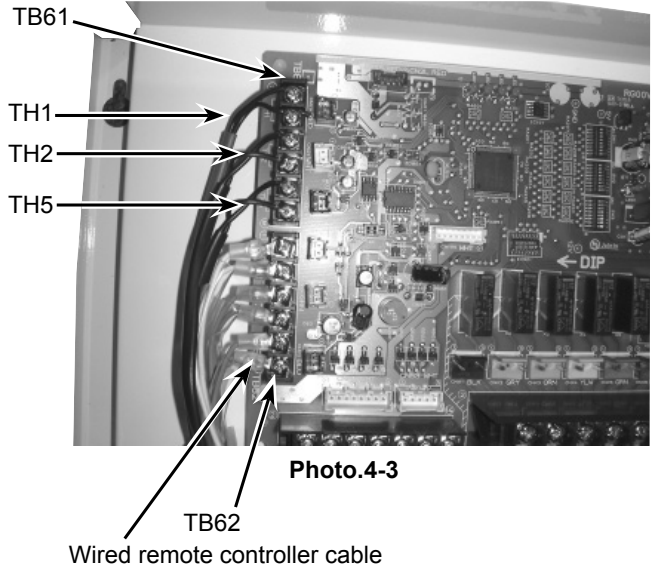
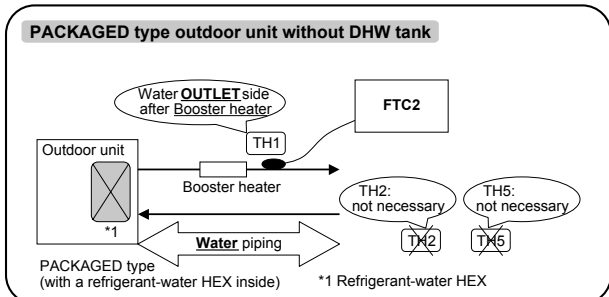
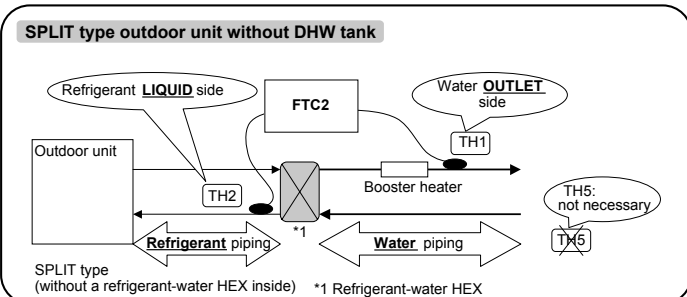
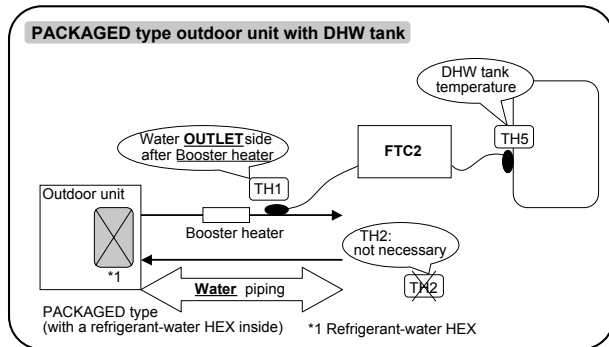
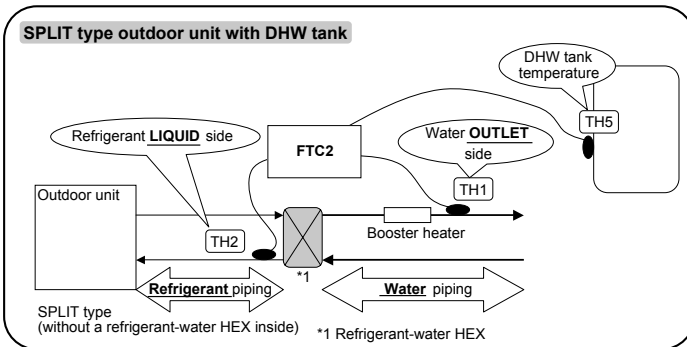

Photo.4-3

Wired remote controller cable



4. Electrical work

4.5. Connecting external output signal

All outputs has AC 230V signal

Output	Use	Signal	Max. current
OUT1	Water circulation pump	AC 230A signal for relay drive	0.5 A
OUT2	Booster heater 1	AC 230A signal for relay drive	0.5 A
OUT3	Booster heater 2	AC 230A signal for relay drive	0.5 A
OUT4	Immersion heater	AC 230A signal for relay drive	0.5 A
OUT5	3-port valve	AC 230A signal for relay drive	0.5 A
OUT6	Defrost	AC 230A signal for direct use	0.5 A
OUT7	Error output	AC 230A signal for direct use	0.5 A

*FTC2 has **terminal beds** for AC 230V output signal. (Relays are **NOT** available on FTC2)

Caution :

**Do not drive directly the pump, heater and valve by these output signals.
Connect the surge absorber according to the load at site.**

Wiring specification of External output

Locally supplied parts

Item	Name	Model and specifications
External output function	External output signal wire	Use sheathed vinyl coated cord or cable. Max. 50m Wire type : CV, CVS or equivalent Wire size : Stranded wire 0.5mm ² to 1.25mm ² Solid wire: ϕ 0.65mm to ϕ 1.2mm
	Relay, etc.	AC 230V signal 0.5 A or less *Connect the surge absorber according to the load at site.

TB141

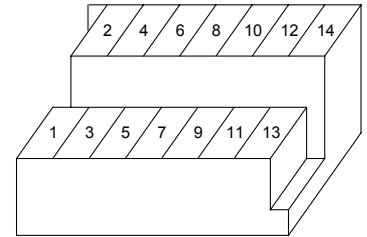

5. Switch setting of FTC2

The functionality of the heat pump is determined by the setting of the Dip switches from SW1 to SW3, and SW6 found on the FTC2 controller. (Photo. 5-1)

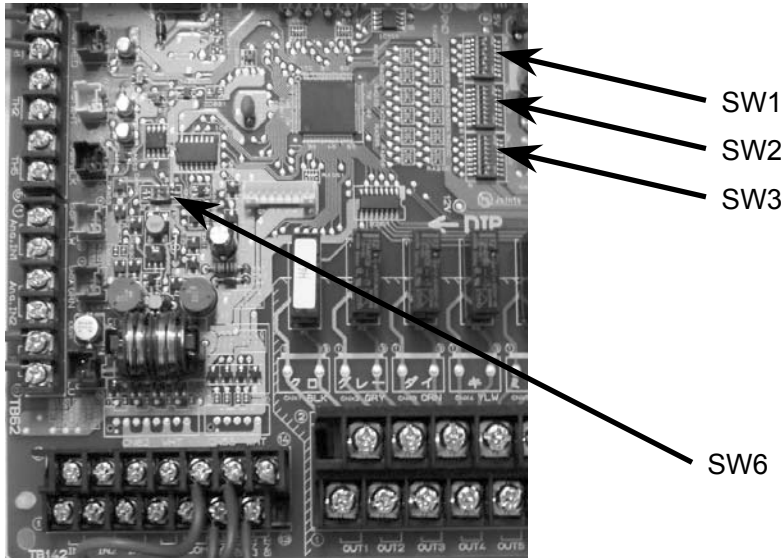

Photo. 5-1

5.1 Operation mode input method

Input method can be selected with Dip SW 1-1 / 1-2

ON/OFF Input	Change mode Input	Change TEMP. Input	SW1-1	SW1-2	SW6-1	SW6-2
Wired remote controller (PAR-W21MAA)	Wired remote controller (PAR-W21MAA) or External input	Wired remote controller (PAR-W21MAA)	OFF	OFF	OFF	OFF
External input (non-voltage contact)	External input (non-voltage contact)	Wired remote controller (PAR-W21MAA)	ON	OFF	OFF	OFF
Analog input (1-5V) *1	External input (non-voltage contact)	Analog input (1-5V)	OFF	ON	OFF	ON
Analog input (4-20mA) *2	External input (non-voltage contact)	Analog input (4-20mA)	OFF	ON	ON	ON
External input (non-voltage contact)	External input (non-voltage contact)	Analog input (0-10V)	ON	ON	OFF	OFF

*1. 4-20mA ... OFF: 0 ~ 2mA

*2. 1-5V ... OFF: 0 ~ 0.5V

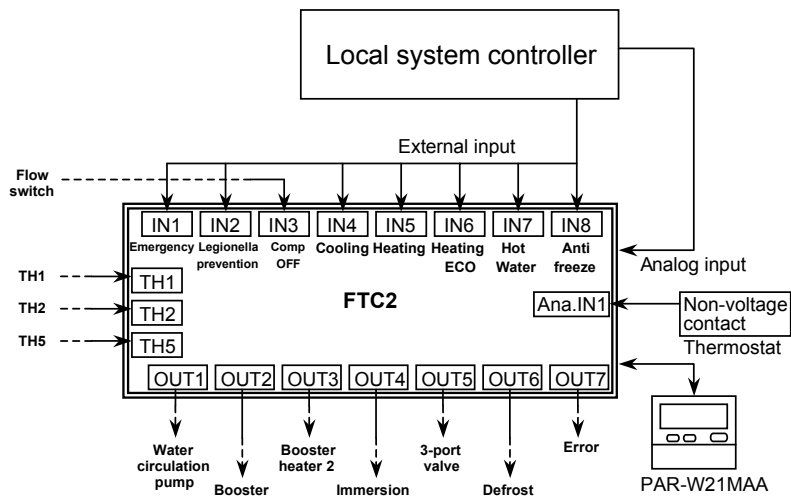

5.2. Thermistor setting

Set Dip SW 1-3 according to whether the system has a DHW tank.

SW 1-3	Setting	Notes
OFF	With DHW tank	Necessary to connect TH5
ON	Without DHW tank	NOT necessary to connect TH5

When Dip SW 1-3 is ON, DHW mode is NOT available.

Set Dip SW 1-6 according to the connected Heat pump unit type.

SW 1-6	Setting	Notes
OFF	SPLIT type	Necessary to connect TH2
ON	PACKAGED type	NOT necessary to connect TH2

5. Switch setting of FTC2

5.3. Heater setting

Set Dip SW 1-4 according to whether the system has an Immersion heater.

SW 1-4	Setting
OFF	Without Immersion heater
ON	With Immersion heater

Set Dip SW 1-5 according to the location of Booster heater.

SW 1-5	Setting
OFF	For both Domestic Hot Water (DHW) and Heating
ON	For Heating only or without Booster heater

< Summary: Heater setting >

SW 1-4 Immersion heater	SW 1-5 Booster heater position	Figure
OFF (Without Immersion heater)	OFF (For both DHW and Heating)	
ON (With Immersion heater)	OFF (For both DHW and Heating)	
OFF (Without Immersion heater)	ON (For Heating only)	
ON (With Immersion heater)	ON (For Heating only)	

5.4. Other setting

Set Dip SW 1-7 according to the Cooling mode usage.

SW 1-7	Setting
OFF	Not in use (Operation mode: Heating/Heating ECO/Hot Water/Anti-freeze)
ON	In use (Operation mode: Heating/Heating ECO/Hot Water/Anti-freeze/Cooling)

When Dip SW 1-7 is OFF, Cooling mode is NOT available.

Dip SW 3-4: External input (Ana. IN1) logic change

External input (Ana. IN1) is for the connection of thermostat.

SW 3-4	Ana. IN1 (TB62 No.1, 2) input	Item
OFF	OFF (open)	Normal operation
	ON (short)	Heat pump unit OFF *1
ON	OFF (open)	Heat pump unit OFF *1
	ON (short)	Normal operation

*1 In case of Cooling, Heating, Heating Eco, Anti-freeze.

Dip SW 3-6: External input (IN1) logic change

SW 3-6	IN1 (TB142 No.5, 6) input	Item
OFF	OFF (open)	Normal operation
	ON (short)	Heat pump unit OFF
ON	OFF (open)	Heat pump unit OFF
	ON (short)	Normal operation

Dip SW 3-5, 3-8: Not in use. Set to OFF. (Initial setting)

6. Operation setting

6.1. Automatic change over mode

When a system includes a Domestic Hot Water (DHW) tank and a space heating requirement Automatic change over mode should be selected. Selection is made with Dip SW1-8.

If the system does NOT include a DHW tank Dip SW 1-3 is ON and Automatic change over mode is invalid.

SW 1-8	Operation
OFF	With Automatic change over mode (the system has a DHW tank).
ON	Without Automatic change over mode (the system does NOT have a DHW tank). OR The end user would like to control the switch over between DHW and space heating.

Operations on each mode **with** Automatic change over mode.

Mode	System operation
Heating	Heating and DHW (Automatic change over mode)
Heating ECO	Heating with Weather compensation and DHW (Automatic change over mode)
Hot Water	Domestic Hot Water only
Anti-freeze	Prevents pipe work freezing during periods of inactivity

Operations on each mode **without** Automatic change over mode.

Mode	System operation
Heating	Heating only
Heating ECO	Heating only with Weather compensation
Hot Water	Domestic Hot Water only
Anti-freeze	Prevents pipe work freezing during periods of inactivity

When automatic change over mode is selected DHW always has priority over space heating.

System examples

Example 1:

Only our Remote controller (PAR-W21MAA) is used for system control. NO local system controller exists.

Target temperature for each mode and Heating or Heating ECO mode are set with PAR-W21MAA. Automatic change over mode is selected (SW 1-8 must be switched to OFF). The system will automatically change from Heating or Heating ECO to DHW mode and back dependent on the DHW tank temperature (TH5).

SW 1-1 OFF / SW 1-2 OFF / SW 1-8 OFF

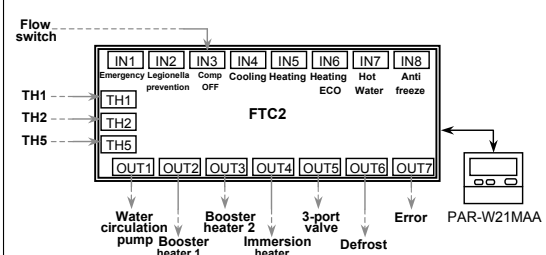

Example 2:

A local timer and our Remote controller (PAR-W21MAA) are used for system control.

Target temperature for each mode and Heating or Heating ECO mode are set with PAR-W21MAA.

A local timer is used rather than automatic change over mode (SW1-8 must be switched to ON). The system runs in Heating or Heating ECO until a signal is received from the local timer (the signal received from local timer must be longer than 5 secs). The system then switches to DHW mode. Once DHW mode is satisfied the system automatically reverts to Heating or Heating ECO.

SW 1-1 OFF / SW 1-2 OFF / SW 1-8 ON

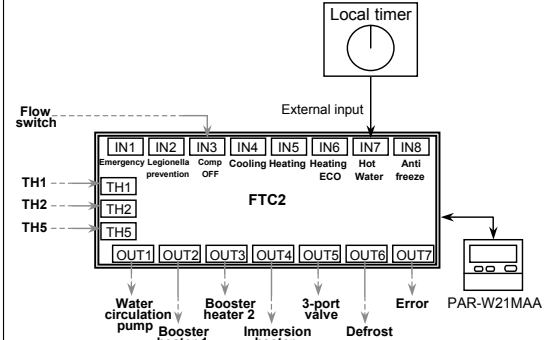

6. Operation setting

System examples

Example 3:

A Local controller and our Remote controller (PAR-W21MAA) are used for system control.

Target temperatures for each mode are set with PAR-W21MAA.
A local controller is used to select the running mode rather than Automatic change over mode (SW 1-8 must be switched to ON).

<IMPORTANT NOTE>

In this system, the operation mode must be switched by a local controller which can output separate signals for each operation mode.
(This can be realised by using a schedule timer and relays.)

SW 1-1 ON / SW 1-2 OFF / SW 1-8 ON

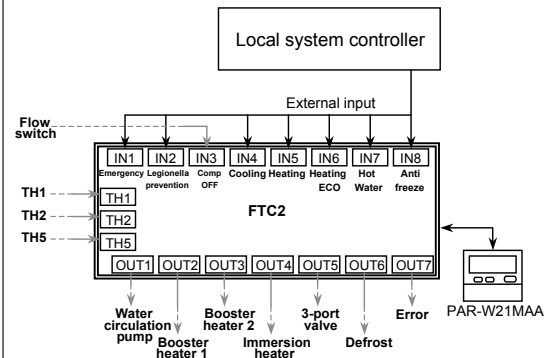

Example 4:

ONLY a Local controller is used for system control.

The system operates in the same way as Example 3 except that the target temperatures for each mode must also be inputted via the analogue signal from the local controller. (SW1-8 must be switched to ON)

<IMPORTANT NOTE>

In this system, the operation mode must be switched by a local controller which can output separate signals for each operation mode. In addition, the target temperature in each operation mode must be sent by ANALOG signal from the local controller.

SW 1-1 OFF / SW 1-2 ON / SW 1-8 ON
or SW 1-1 ON / SW 1-2 ON / SW 1-8 ON

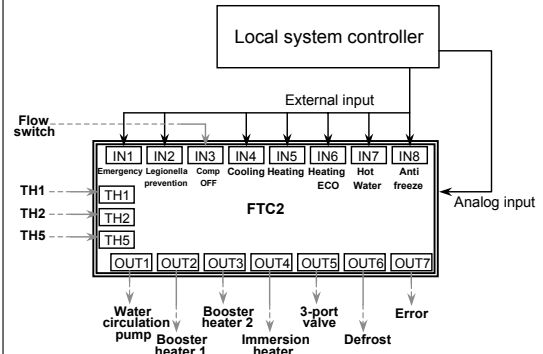

6.2. DHW OFF conditions

DHW can be selected in 2 ways

Pattern 1.

An external input or remote controller is used to switch to DHW mode.

DHW pattern 1 will turn off when the DHW tank reaches set temperature consecutively for **1 minute**.

Then the heat pump will turn OFF

Pattern 2.

Automatic change over mode or an external input (e.g. Local timer – signal received must last > 5secs) is used to switch to DHW mode.

DHW pattern 2 will switch off under the following conditions;

- The DHW tank reaches set temperature T_{HW} consecutively for **1 minute**.
- The system has been in DHW mode consecutively for H_{time} (minutes)

(This allows the system to switch back to Heating or Heating Eco mode should the system fail to reach the set temperature for any reason)

System operation status at start-up	H_{time} (minutes)
<ul style="list-style-type: none"> • First power-on • First starting up after Initial filling up • $TH5 < 25$ deg C (Tank temperature is low.) 	300
• Others	180

* As shown in the table, H_{time} becomes longer when the water temperature in the tank is low. This is to delay the operation switchover to Heating mode.

Then the heat pump will revert to Heating or Heating Eco mode.

6. Operation setting

6.3. DHW Heating Procedure

The heating of DHW tank is done in 2 stages, firstly the "Heat pump phase" followed by the "Electric heater phase".

6.3.1. Heat Pump Phase

The Heat pump phase for DHW mode, is used when the temperature difference between tank set temperature and TH5 is either 10 deg C or 20 deg C (ΔT_H)

ΔT_H is selected using Dip SW2-1

SW 2-1	Operation
OFF	$\Delta T_H = 10 \text{ deg C}$
ON	$\Delta T_H = 20 \text{ deg C}$

The heat pump will turn off or revert to heating when:

Tank temperature (TH5) > DHW set temperature consecutively for 1 minute.

Heat Pump Operation

The heat pump will be controlled directly by the FTC2 while in DHW mode. The operation characteristics can be selected using Dip SW2-2.

Option 1 – COP priority mode

In this mode the heat pump will heat the water over a slightly longer period of time with a controlled frequency, improving the coefficient of performance. The result of this will be a more economical DHW heat up.

Option 2 – Speed priority mode

In this mode the heat pump will run at maximum frequency during DHW heat up. The result of this will be a reduced time to heat the tank but also a reduction in COP and so an increase in energy consumption.

SW 2-2	Operation
OFF	COP priority mode (Operation frequency is controlled to have higher COP.)
ON	Speed priority mode (Heat pump unit runs at the maximum frequency to reduce operation time.)

There is a 30 sec. delay in the Heat pump unit start to ensure the water circulation pump starts running before the Heat pump unit.

Other factors in the Heat pump phase

Heat pump status	Water circulation pump status	3-port valve status	Booster heater 1 status	Booster heater 2 status	Immersion heater status
ON for DHW	ON	ON	Electric heaters are not used in the Heat pump phase		
OFF for DHW	OFF	OFF			

6.3.2. Electric Heater Phase

Electric heater phase for DHW, is used when tank temperature (TH5) is less than DHW set temperature and the temperature increase in 10 minutes is smaller than 1 deg C.

Electric heater phase will switch off when:

Tank temperature TH5 > DHW set temperature consecutively for 1 minute.

Electric Heater Phase Operation

The electric heater phase will vary dependent on the position of the heater within the heating circuit.

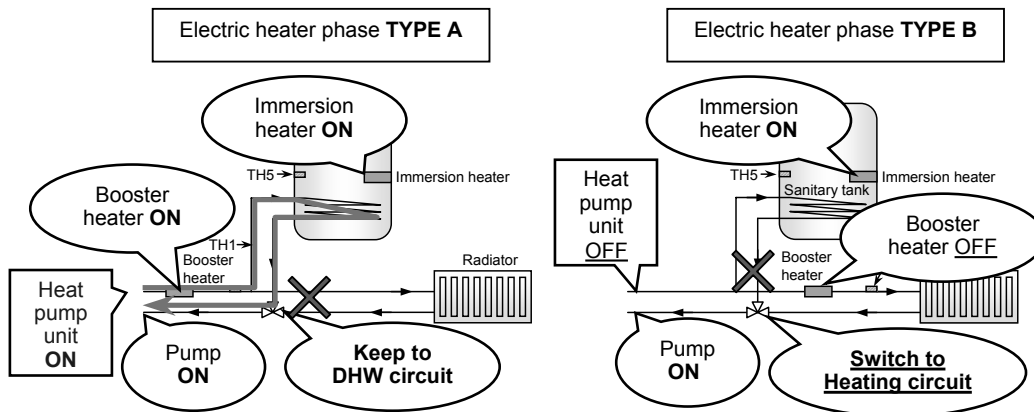

The Dip switch settings for this operation are given in the following table.

SW 1-4 (Immersion heater)	SW1-5 (Booster heater)	SW 2-7	
		OFF (Immersion heater used)	ON (Immersion heater not used or only for Legionella)
OFF (without IH)	OFF (BH for both DHW and Heating)	TYPE A	TYPE A
ON (with IH)	OFF (BH for both DHW and Heating)	TYPE A	TYPE A
OFF (without IH)	ON (BH for Heating only)	No heater in DHW circuit	No heater in DHW circuit
ON (with IH)	ON (BH for Heating only)	TYPE B	No heater in DHW circuit

* BH : Booster heater IH : Immersion heater

6. Operation setting

System Characteristics

System type	Heat pump status	Water circulation pump status	3-port valve status	Booster heater 1 status	Booster heater 2 status	Immersion heater status
A (SW1-5 OFF)	ON	ON	ON	ON	ON	ON
B (SW1-4 ON, SW1-5 ON, SW2-7 OFF)	OFF	ON	OFF	OFF	OFF	ON

Heater operation at Electric heater phase in Domestic Hot Water mode

SW 1-4 (Immersion heater)	SW1-5 (Booster heater)	SW 2-7	
		OFF (Immersion heater used)	ON (Immersion heater not used or only for Legionella)
OFF (without IH)	OFF (BH for both DHW and Heating)	BH1,2 : ON IH : OFF	BH1,2 : ON IH : OFF
ON (with IH)	OFF (BH for both DHW and Heating)	BH1,2 : ON IH : ON	BH1,2 : ON IH : OFF
OFF (without IH)	ON (BH for Heating only)	No heater in DHW circuit	No heater in DHW circuit
ON (with IH)	ON (BH for Heating only)	BH1,2 : OFF IH : ON	No heater in DHW circuit

* BH : Booster heater IH : Immersion heater

6.4. Legionella Prevention mode

It is recommended that sanitary hot water stored in tanks is heated periodically to 60 deg C or above for the prevention of Legionella.

In Legionella prevention mode, the system runs to let the temperature in the DHW tank (TH5) reach T_{LP} deg C. The temperature T_{LP} can be set using Dip SW 2-6.

SW 2-6	Setting temperature
OFF	$T_{LP}=60$ deg C
ON	$T_{LP}=65$ deg C

The 65 deg C setting can NOT be selected when there is no heater in the DHW circuit, Dip SW settings is as follows; SW 1-4 OFF and SW1-5 ON

6.4.1. Start Condition and Finish Conditions

How often the Legionella prevention operation is activated is selected using Dip SW 2-4 and 2-5.

SW 2-4	SW 2-5	Operation
OFF	OFF	Activate every DHW operation.
ON	OFF	Activate every "15 times" DHW operations.
OFF	ON	Activate every "150 times" DHW operations.
ON	ON	Activate by external input signal (IN2)

Legionella prevention mode is satisfied when $TH5 > T_{LP}$ deg C consecutively for **1 minute**

The Legionella prevention mode is satisfied in 2 stages, firstly the heat pump phase followed by the electric heater phase.

Electric heater phase is required if tank temperature (TH5) does not increase for some reason or once TH5 reaches the set temperature T_{HW} .

Start Electric heater phase conditions:

TH5 temperature increase in **10 minutes < 1 deg C** **OR**
 TH5 > DHW set temperature (T_{HW}) consecutively for **1 minute**

Finish Electric heater phase condition:

TH5 > T_{LP} deg C consecutively for **1 minute**

6.5. Heating and Heating ECO mode

Choice of either Heating or Heating ECO mode is made using the PAR-W21MAA or local controller. Both modes use the Heat pump to heat the water to the set point T_{HE} and then allow for the use of Booster heaters if present on the heating circuit to raise the space heating flow temp (TH1) if needed.

There is a 1 minute delay before the Heat pump unit starts, so that the Water circulation pump starts running earlier than the Heat pump.

6.5.1. Water Circulation Pump

In Heating or Heating ECO mode the Water circulation pump can be either on continually or turned off 5 minutes after the Heat pump unit stops operating at which point it will then cycle ON for 1 minute OFF for 3 minutes repeatedly. The setting is selected using Dip SW2-3

SW 2-3	Operation
OFF	Always ON (to prevent water circuit from freezing)
ON	OFF 5 minutes after Heat pump unit stops operation. Then the pump will switch ON for 1 minute OFF for 3 minutes repeatedly until the heat pump starts again.

6.5.2. Booster Heater

If Booster heater is NOT used in Heating mode, Dip SW2-8 must be switched ON.

SW 2-8	Operation
OFF	Booster heater used in Heating mode
ON	Booster heater is NOT used in Heating mode (Booster only used in DHW mode, Legionella prevention mode and Emergency mode)

6. Operation setting

6.6. Defrost operation

The heat pump process requires regular defrost cycles. The FTC2 operates as follows when the system receives defrost signal and when it completes defrosting.

6.6.1. When defrost signal is received

3-port valve

In DHW mode the 3-port valve remains ON.

In heating mode the valve can be OFF enabling the Heat pump unit to defrost while keeping the heat in the heating circuit or switched to ON so system is defrosted using accumulated heat.

Selection is made using Dip SW3-1

SW 3-1	Operation
OFF	Remains OFF (defrost while keeping Heating circuit).
ON	Switch to ON (switch to DHW circuit to defrost. The system defrosts using accumulated heat for defrosting).

Other factors in the Defrost operation

Heat pump status	Water circulation pump status	Booster heater 1 status	Booster heater 2 status	Immersion heater status
Defrost operation	ON	Electric heaters have the same control in each mode		

6.6.2. When System completes defrost operation

All water circuit parts return to normal settings except for the Heat pump unit.

Heat Pump unit

If the unit was running in Heating or Heating ECO previous to the defrost cycle the system restricts the maximum frequency for 10 minutes from completion of defrost. In this time it considers the operation it was previously performing.

* The maximum frequency shall be restricted as follows depending on the temperature drop of outlet water during the defrost operation.

Temperature differential at the beginning of defrost operation	Operation
$T_{HE} - TH1 \geq 2 \text{ deg C}$	Maximum frequency is NOT restricted.
$T_{HE} - TH1 < 2 \text{ deg C}$	Maximum frequency is restricted for 10 minutes .

6.7. Cooling mode (not available on some models)

Cooling mode works in a similar manner to Heating mode. The heat pump unit is controlled by the FTC2 and has a 1 minute delay in starting to allow for the Water circulation pump to start before the Heat pump unit.

The operation of the Water circulation pump is selected using Dip SW 2-3 as before

SW 2-3	Operation
OFF	Always ON (to prevent water circuit from freezing)
ON	OFF 5 minutes after Heat pump unit stops operation. Then the pump will switch ON for 1 minute OFF for 3 minutes repeatedly until the heat pump starts again.

The 3-port valve is always OFF in Cooling mode.

The Booster heaters and the Immersion heater are always OFF in Cooling mode.

6.8. Anti-freeze mode

Anti-freeze mode is selected using the PAR-W21MAA or local controller.

Anti-freeze mode characteristics

Anti-freeze mode	Heat pump status	Water circulation pump status	Booster heater 1 status	Booster heater 2 status	Immersion heater status
ON	ON	ON	Booster heaters have same control as in Heating mode		NOT USED
OFF	OFF	ON	OFF		NOT USED

6. Operation setting

6.9. Emergency (electric heater only) mode

Emergency mode is available in case of Heat pump unit's failure. In this mode, only electric heater operates as a heat source. Heat pump unit operation comes first in any operation mode, except in Emergency mode. In the Emergency mode, the heater is switched ON without operating Heat pump unit.

IMPORTANT: If there are no electric heaters in the circuit "Emergency mode" can not operate.

Emergency mode can activated when the system has external input (IN1) or if Dip SW 3-7 is manually switched to ON.

SW 3-7	Operation
OFF	Normal operation
ON	Emergency (electric heater only) mode

6.9.1. Start condition

Emergency mode shall start when one of the following conditions is fulfilled.

- The system has external input (IN1).
- SW 3-7 is ON

6.9.2. Finish condition

Emergency mode shall finish when all of the following conditions are fulfilled.

- The system does NOT have external input (IN1).
- SW 3-7 is OFF

Operation mode is selected by local system controller or remote controller settings.

6.9.3. In Domestic Hot Water mode

Heat pump unit is OFF.

Electric heater phase starts immediately.

When the switch setting is for "No heater in DHW circuit", phase can NOT be switched to Electric heater phase. (System keeps thermo OFF.)

6.9.4. In Legionella prevention mode

Heat pump unit is OFF.

Electric heater phase starts immediately.

When the switch setting is for "No heater in DHW circuit", phase can NOT be switched to Electric heater phase. (System finishes Legionella prevention mode.)

6.9.5. In Heating and Anti-freeze mode

Heat pump status	Water circulation pump status	Booster heater 1 status	Booster heater 2 status	Immersion heater status
OFF	ON	ON when Heat pump runs consecutively for 0 minute AND $T_{HE} - TH1 \geq 1 \text{ deg C}$	ON when BH1 is ON consecutively for 10 minutes AND $T_{HE} - TH1 \geq 1 \text{ deg C}$	NOT USED

6.9.6. Return to Normal operation

When returning from Emergency (electric heater only) mode to Normal operation mode, stop sending the signal of external input (IN1) and switch off Dip SW 3-7.

Then turn off the power of the outdoor unit and FTC2, and start up the system again.

6. Operation setting

6.10. SUMMARY of Dip Switch Functions

Dip switch		Function	OFF			ON		
SW1	SW1-1	System select	SW1-1	SW1-2	ON/OFF Input	Change mode Input	Change TEMP. Input	
			OFF	OFF	Remote controller	Remote controller	Remote controller	
	SW1-2		ON	OFF	External input			Remote controller
			OFF	ON	Analog input (4-20mA/1-5V)	External input	Analog input (4-20mA/1-5V)	
			ON	ON	External input			Analog input (0-10V)
	SW1-3		Domestic Hot Water tank	with DHW tank			without DHW tank	
	SW1-4		Immersion heater	without Immersion heater			with Immersion heater	
SW1-5	Booster heater position	For both DHW and Heating			For Heating only or without Booster heater			
SW1-6	Connected Heat pump unit type	SPLIT type			PACKAGED type			
SW1-7	Cooling mode usage	Not in use			In use			
SW1-8	Automatic change over mode	with Automatic change over mode			without Automatic change over mode			
SW2	SW2-1	Thermo differential in DHW mode	10 deg C			20 deg C		
	SW2-2	H/P unit control in DHW mode	COP priority mode			Speed priority mode		
	SW2-3	Water circulation pump control in Heating mode	Always ON			OFF 5 min. after H/P unit stops		
	SW2-4	Legionella prevention mode select	SW2-4		SW2-5	Operation		
			OFF	OFF	Activate every DHW operation.			
	ON		OFF	Activate every "15 times" DHW operations.				
	OFF		ON	Activate every "150 times" DHW operations.				
	SW2-5		ON	ON	Activate by external input signal (IN2)			
SW2-6	Set temperature in Legionella prevention mode	60 deg C			65 deg C			
SW2-7	Immersion heater usage in Domestic Hot Water mode	In use			Not in use			
SW2-8	Booster heater usage in Heating mode	In use			Not in use			
SW3	SW3-1	3-port valve control during defrost in Heating mode	OFF (Heating circuit)			ON (Domestic Hot Water circuit)		
	SW3-2	Pump control for Initial filling up	OFF			ON		
	SW3-3	3-port valve control for Initial filling up	OFF			ON		
	SW3-4	External input (Ana. IN1) logic change	Comp. OFF at short			Comp. OFF at open		
	SW3-5	-	-			-		
	SW3-6	External input (IN3) logic change	Comp. OFF at short			Comp. OFF at open		
	SW3-7	Emergency (electric heater only) mode	Normal operation			Emergency (electric heater only) mode		
	SW3-8	-	-			-		
SW6	SW6-1	Analog input setting	SW6-1		SW6-2		Analog input setting	
			OFF	OFF	0-10 V or Analog input is not in use			
	ON		OFF	—				
	SW6-2		OFF	ON	1-5 V			
ON		ON	4-20 mA					

7. Before test run

7.1. Check

After completing installation and the wiring and piping of the local application and outdoor units, check for refrigerant leakage, looseness in the power supply or control wiring, wrong polarity, and no disconnection of one phase in the supply.

Use a 500-volt megohmmeter to check that the resistance between the power supply terminals and ground is at least 1.0MΩ.

⚠ Warning:

Do not use the system if the insulation resistance is less than 1.0MΩ.

⚠ Caution:

Do not carry out this test on the control wiring (low voltage circuit) terminals.

7.2. Self-check

① Turn on the power.

② Press [CHECK] button twice.

③ Press [CHECK] button twice to finish self-check.

Ⓐ CHECK button Ⓑ IC : FTC2 unit Ⓒ : Outdoor unit Ⓓ Check code

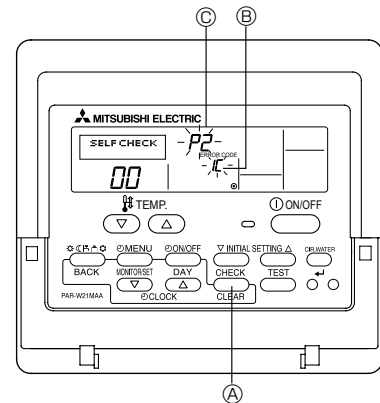

Check code	Symptom
P1	Flow water (TH1) sensor error
P2	Refrigerant liquid Pipe (TH2) sensor error
P6	Freezing/Overheating protection operation
P9	Actual tank temp. (TH5) sensor error
Fb	FTC2 unit control system error (memory error, etc.)
E0~E5	Signal transmission failure between remote controller and FTC2.
E6~EF	Signal transmission failure between outdoor unit and FTC2.
----	No trouble generated in the past.
FFFF	No corresponding unit
U*, F*	Outdoor unit failure. Refer to the outdoor unit wiring diagram.

For description of each LED(LED1~5) provided on the FTC2, refer to the following table.

LED 1 (Power for microcomputer)	Indicates whether control power is supplied. Make sure that this LED is always lit.
LED 2 (Power for remote controller)	Indicates whether power is supplied to the remote controller. This LED lights only in the case of the FTC2 unit which is connected to the outdoor unit refrigerant address "0".
LED 3 (Communication between FTC2 and outdoor unit)	Indicates state of communication between the FTC2 and outdoor unit. Make sure that this LED is always blinking.
LED 4 for maintenance	—
LED 5 for maintenance	—

7.3. Initial filling up

When the system is installed, the whole circuit must be filled with water. At this stage, Water circulation pump and 3-port valve shall be operated individually.

Water circulation pump operates according to Dip SW 3-2 setting.

SW 3-2	Operation
OFF	Water circulation pump is OFF.
ON	Water circulation pump is ON. (It is switched OFF after 60 minutes consecutive operation.)

3-port valve operates according to Dip SW 3-3 setting.

SW 3-3	Operation
OFF	3-port valve is OFF.
ON	3-port valve is ON. (It is switched OFF after 60 minutes consecutive operation.)

*** NOTE**

Even if you forget to reset the Dip SW settings above, the normal operation mode can be recovered automatically in **60 minutes**.

8. Remote controller operation

Note (Marking for WEEE)



This symbol mark is for EU countries only.

This symbol mark is according to the directive 2002/96/EC Article 10 Information for users and Annex IV.

Your MITSUBISHI ELECTRIC product is designed and manufactured with high quality materials and components which can be recycled and re-used.

This symbol means that electrical and electronic equipment, at their end-of-life, should be disposed of separately from your household waste.

Please, dispose of this equipment at your local community waste collection/recycling centre.

In the European Union there are separate collection systems for used electrical and electronic product.

Please, help us to conserve the environment we live in!

8.1. Safety precautions

- ▶ Before installing the unit, make sure you read all the “Safety Precautions”.
- ▶ The “Safety Precautions” provide very important points regarding safety. Make sure you follow them.
- ▶ Please report to or take consent by the supply authority before connection to the system.

Symbols used in the text

⚠ Warning:

Describes precautions that should be observed to prevent danger of injury or death to the user.

⚠ Caution:

Describes precautions that should be observed to prevent damage to the unit.

Symbols used in the illustrations

⚡ : Indicates a part which must be grounded.

⚠ Warning:

- For appliances not accessible to the general public.
- The unit must not be installed by the user. Ask the dealer or an authorized company to install the unit. If the unit is installed improperly, water leakage, electric shock or fire may result.
- Do not stand on, or place any items on the unit.
- Do not splash water over the unit and do not touch the unit with wet hands. An electric shock may result.
- Do not spray combustible gas close to the unit. Fire may result.
- Do not place a gas heater or any other open-flame appliance where it will be exposed to the air discharged from the unit. Incomplete combustion may result.
- Do not remove the front panel or the fan guard from the outdoor unit when it is running.

- When you notice exceptionally abnormal noise or vibration, stop operation, turn off the power switch, and contact your dealer.
- Never insert fingers, sticks etc. into the intakes or outlets.
- If you detect odd smells, stop using the unit, turn off the power switch and consult your dealer. Otherwise, a breakdown, electric shock or fire may result.
- This air conditioner is NOT intended for use by children or infirm persons without supervision.
- Young children must be supervised to ensure that they do not play with the air conditioner.
- If the refrigeration gas blows out or leaks, stop the operation of the air conditioner, thoroughly ventilate the room, and contact your dealer.
- Do not install in location that is hot or humid for long periods of time.

⚠ Caution:

- Do not use any sharp object to push the buttons, as this may damage the remote controller.
- Never block or cover the indoor or outdoor unit's intakes or outlets.

Disposing of the unit

When you need to dispose of the unit, consult your dealer.

8. Remote controller operation

8.2. Parts name

■ Wired Remote-Controller

Display Section

For purposes of this explanation, all parts of the display are shown. During actual operation, only the relevant items will be displayed.

Identifies the current operation

Shows the operating mode, etc.
* Multi language display is supported.

“Centrally Controlled” indicator

Indicates that operation of the remote controller has been prohibited by a master controller.

“Timer is Off” indicator

Indicates that the timer is off.

Temperature Setting

Shows the target temperature.

Day-of-Week

Shows the current day of the week.

Time/Timer Display

Shows the current time, unless the simple or Auto Off timer is set. If the simple or Auto Off timer is set, shows the time remaining.

ON/OFF indicator

Indicates if timer is set ON/OFF.

“Locked” indicator

Indicates that remote controller buttons have been locked.

Timer indicators

The indicator comes on if the corresponding timer is set.

Error indicator

Comes on when error occurs.

Temperature indicator

Shows the current water temperature.

● (Power On indicator)

Indicates that the power is on.

Operation Section

Set Temperature buttons

▽ Down

△ Up

Timer Menu button (Monitor/Set button)

Mode button (Return button)

Set Time buttons

▽ Back

△ Ahead

Timer On/Off button (Set Day button)

ON/OFF button

Setting change button

CIR. WATER button (<Enter> button)

Not available

TEST run function is not available with this FTC2 unit.

Self check (Clear) button

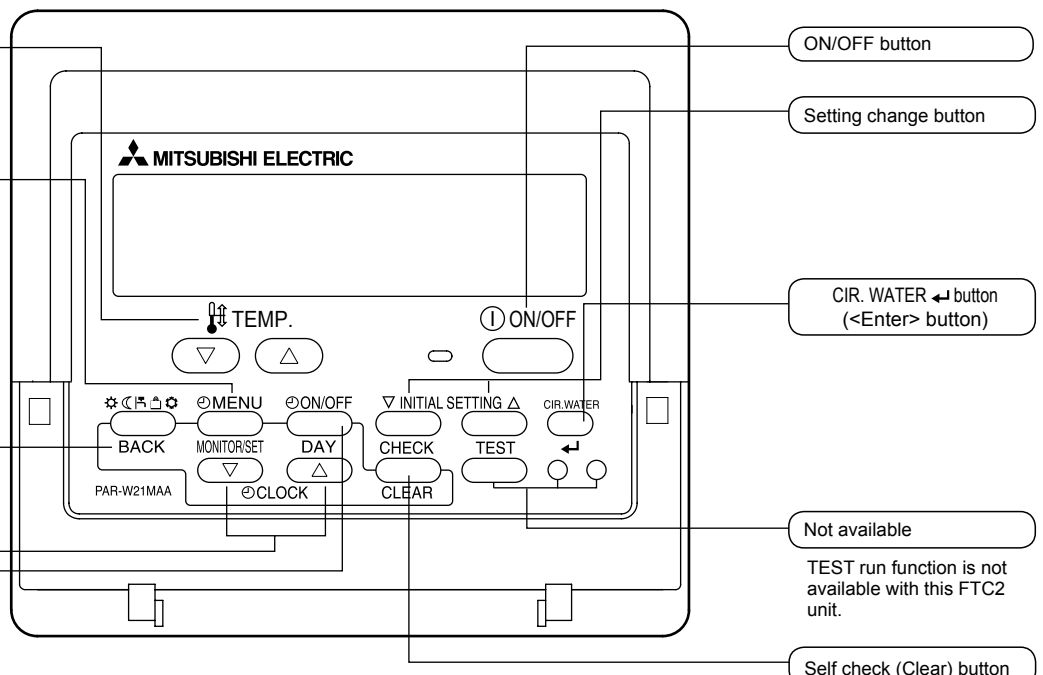
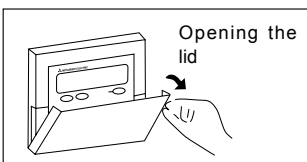

Note:

- “PLEASE WAIT” message
This message is displayed for approximately 3 minutes when power is supplied to the FTC2 unit or when the unit is recovering from a power failure.
- “NOT AVAILABLE” message
This message is displayed if a button is pressed to operate a function that the FTC2 unit does not have, or a function that is not available due to the setting.

8. Remote controller operation

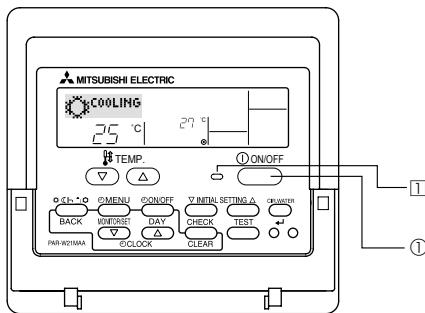
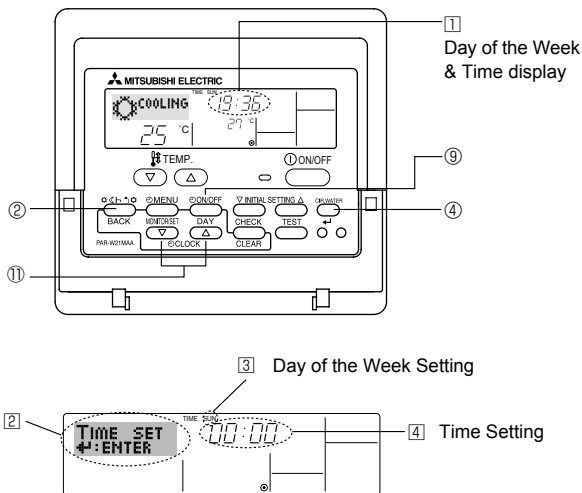
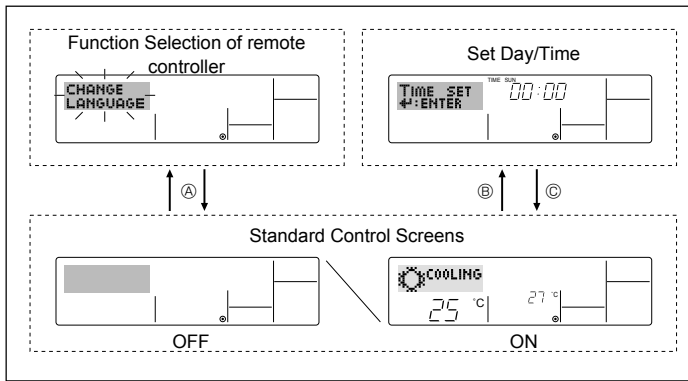

<Screen configuration>

For details on setting the language for the remote controller display, refer to 8.6. Function Selection.

The initial language setting is English.

- Function Selection of remote controller: Set the functions and ranges available to the remote controller (timer functions, operating restrictions, etc.)
- Set Day/Time: Set the current day of the week or time.
- Standard Control Screens: View and set the air conditioning system's operating status

<How to change the screen>

- Ⓐ : Hold down both the Mode button ② and the Timer On/Off button ⑨ for 2 seconds.
- Ⓑ : Press either of the Set Time buttons (▽ or △) ⑪.
- Ⓒ : Press the Mode button ②.

8.3. Setting the day of the week and time

1. Press the ▽ or △ Set Time button ⑪ to show display ②.
2. Press the Timer On/Off (Set Day) button ⑨ to set the day.
 - * Each press advances the day shown at ③ : Sun → Mon → ... → Fri → Sat.
3. Press the appropriate Set Time button ⑪ as necessary to set the time.
 - * As you hold the button down, the time (at ④) will increment first in one-minute intervals, then in ten-minute intervals, and then in 1-hour intervals.
4. After making the appropriate settings at Steps 2 and 3, press the ↵ button ④ to lock in the values.

Note:

The day and time will not appear if clock use has been disabled at Function Selection of remote controller.

8.4. Operation

Available items are different depending on your system. (Refer to section 3.)

8.4.1. Switching

<To Start Operation>

- Press the ON/OFF button ①.
 - The ON lamp ① and the display area come on.

Note:

When the unit restarts, the previous settings are recalled as follows.

	Remote controller setting
Mode	Last operation mode
Temperature setting	Last set temperature

<To Stop Operation>

- Press the ON/OFF button ① again.
 - The ON lamp ① and the display area go dark.

Note:

Even if you press the ON/OFF button to restart the system while turning down the operation, the outdoor unit will not start for about 3 minutes.

This is to prevent the internal components from being damaged.

8. Remote controller operation

8.4.2. Mode select

Press operation mode (⊙⊙⊙⊙) button ② and select operation mode.

- ⊙ Heating mode (Space heating)
- ⊙ Heating ECO mode (Space heating with weather compensation *1)
- ⊙ Hot water mode (Domestic hot water)
- ⊙ Anti freeze mode (Heating to prevent water pipe from freezing)
- ⊙ Cooling mode (Space cooling)

*1 Target flow temp. varies according to the outdoor temperature. (Refer to 9. for setting.)

*2 While Automatic change over mode or Legionella prevention mode, the operation mode is switched in Hot water mode automatically although during the other operation mode. After finishing Automatic change over mode or Legionella prevention mode, the previous operation mode is recalled.

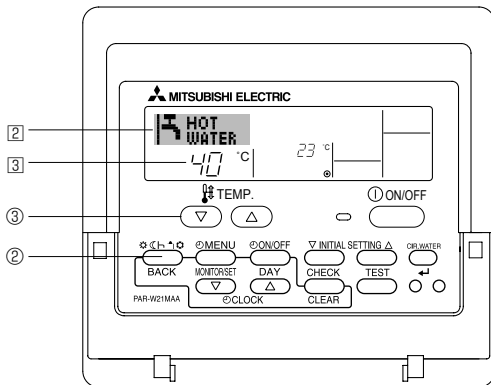

8.4.3. Temperature setting

▶ To decrease the target temperature:

Press (▼) button ③ to set the desired temperature.

The selected temperature is displayed ③.

▶ To increase the target temperature:

Press (▲) button ③ to set the desired temperature.

The selected temperature is displayed ③.

Note: Heating ECO mode sets the set temperature depending on the outdoor temperature.

While Legionella prevention mode, the set temperature is switched in 60 °C or 65 °C automatically.

8.5. Other Functions

8.5.1. Locking the Remote Controller Buttons (Operation function limit)

- If you wish, you can lock the remote controller buttons. You can use the Function Selection of remote controller to select which type of lock to use.

(For information about the lock type, refer to 8.6, item [2].)

Specifically, you can use either of the following 2 lock types.

- ① Lock All Buttons:
Locks all of the buttons on the remote controller.
- ② Lock All Except ON/OFF:
Locks all buttons other than the ON/OFF button.

Note:

The “Locked” indicator appears on the screen to indicate that buttons are currently locked.

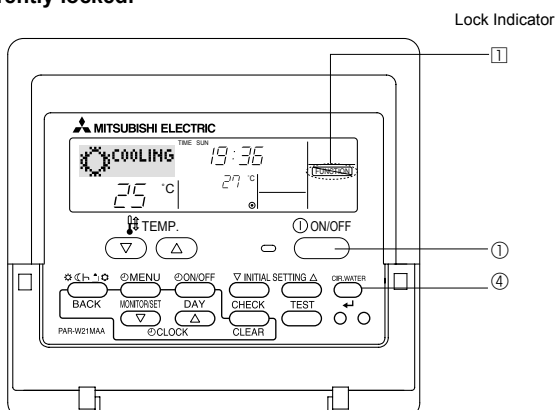

<How to Lock the Buttons>

1. While holding down the CIR. WATER button ④, press and hold down the ON/OFF button ① for 2 seconds. The “Locked” indication appears on the screen (at ①), indicating that the lock is now engaged.

- * If locking has been disabled in Function Selection of remote controller, the screen will display the “Not Available” message when you press the buttons as described above.

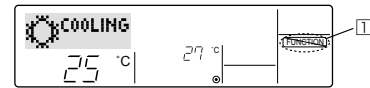

- If you press a locked button, the “Locked” indication (at ①) will blink on the display.

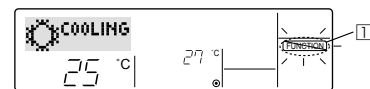

<How to Unlock the Buttons>

1. While holding down the CIR. WATER button ④, press and hold down the ON/OFF button ① for 2 seconds—so that the “Locked” indication disappears from the screen (at ①).

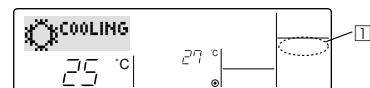

8. Remote controller operation

8.5.2. Error Codes indication

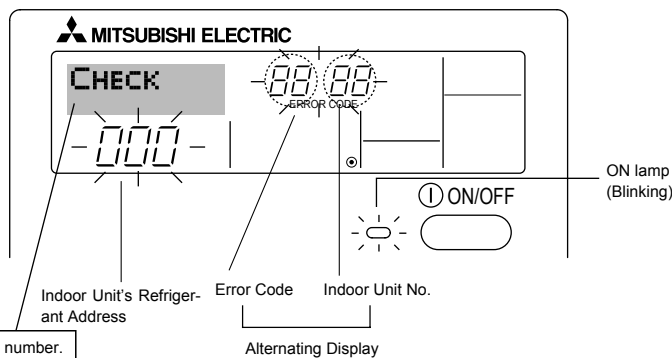

- If the ON lamp and error code are both blinking: This means that the air conditioner is out of order and operation has been stopped (and cannot resume). Take note of the indicated unit number and error code, then switch off the power to the air conditioner and call your dealer or service.

When the Check button is pressed:

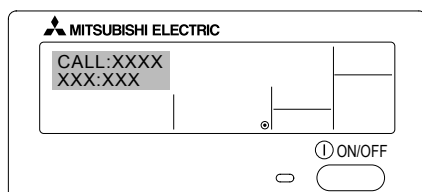
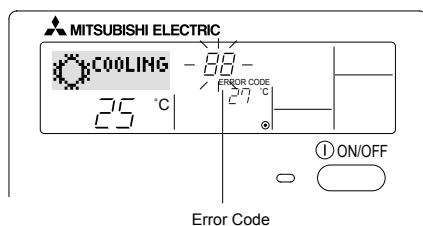

- If only the error code is blinking (while the ON lamp remains lit): Operation is continuing, but there may be a problem with the system. In this case, you should note down the error code and then call your dealer or service for advice.
- * If you have entered contact number to be called in the event of a problem, push the Check button to display it on the screen. (You can set this up under Function Selection of remote controller. For information, refer to 8.6.)

8.6. Function Selection

Various remote controller functions are selectable in the remote controller function selection mode. Change setting when needed.

Item 1	Item 2	Item 3
1. Change language ("CHANGE LANGUAGE")	Language setting to display	<ul style="list-style-type: none"> • Some European languages are selectable.
2. Function limit ("FUNCTION SELECTION")	(1) Operation function limit setting (operation lock) ("LOCKING FUNCTION")	<ul style="list-style-type: none"> • To invalidate some functions.
	(2) Use of operation mode setting ("SELECT MODE")	<ul style="list-style-type: none"> • Setting the use or non-use of operation mode
	(3) Temperature range limit setting ("LIMIT TEMP FUNCTION")	<ul style="list-style-type: none"> • Setting the temperature adjustable range (maximum, minimum)
3. Mode selection ("MODE SELECTION")	(1) Remote controller main/sub setting ("CONTROLLER MAIN/SUB")	<ul style="list-style-type: none"> • Selecting main or sub remote controller * When 2 remote controllers are connected to 1 group, 1 controller must be set to sub.
	(2) Use of clock setting ("CLOCK")	<ul style="list-style-type: none"> • To select the use or non-use of clock function
	(3) Timer function setting ("TIMER MODE")	<ul style="list-style-type: none"> • To select the timer type
	(4) Contact number setting in case of fault ("CALL.")	<ul style="list-style-type: none"> • Contact number display in case of error • To select the telephone number
	(5) Temperature offset setting ("TEMP OFFSET FUNCTION")	<ul style="list-style-type: none"> • To select the use or non-use of the water temperature offset function
4. Display change ("DISP MODE SETTING")	(1) Temperature display °C/°F setting ("TEMP MODE °C/°F")	<ul style="list-style-type: none"> • To select the temperature unit (°C or °F) to display
	(2) Water temperature display setting ("WATER TEMP. DISP. SELECT")	<ul style="list-style-type: none"> • To select the use or non-use of the display of "actual flow water temperature"

8. Remote controller operation

[Function selection flow chart]
Setting language (English)

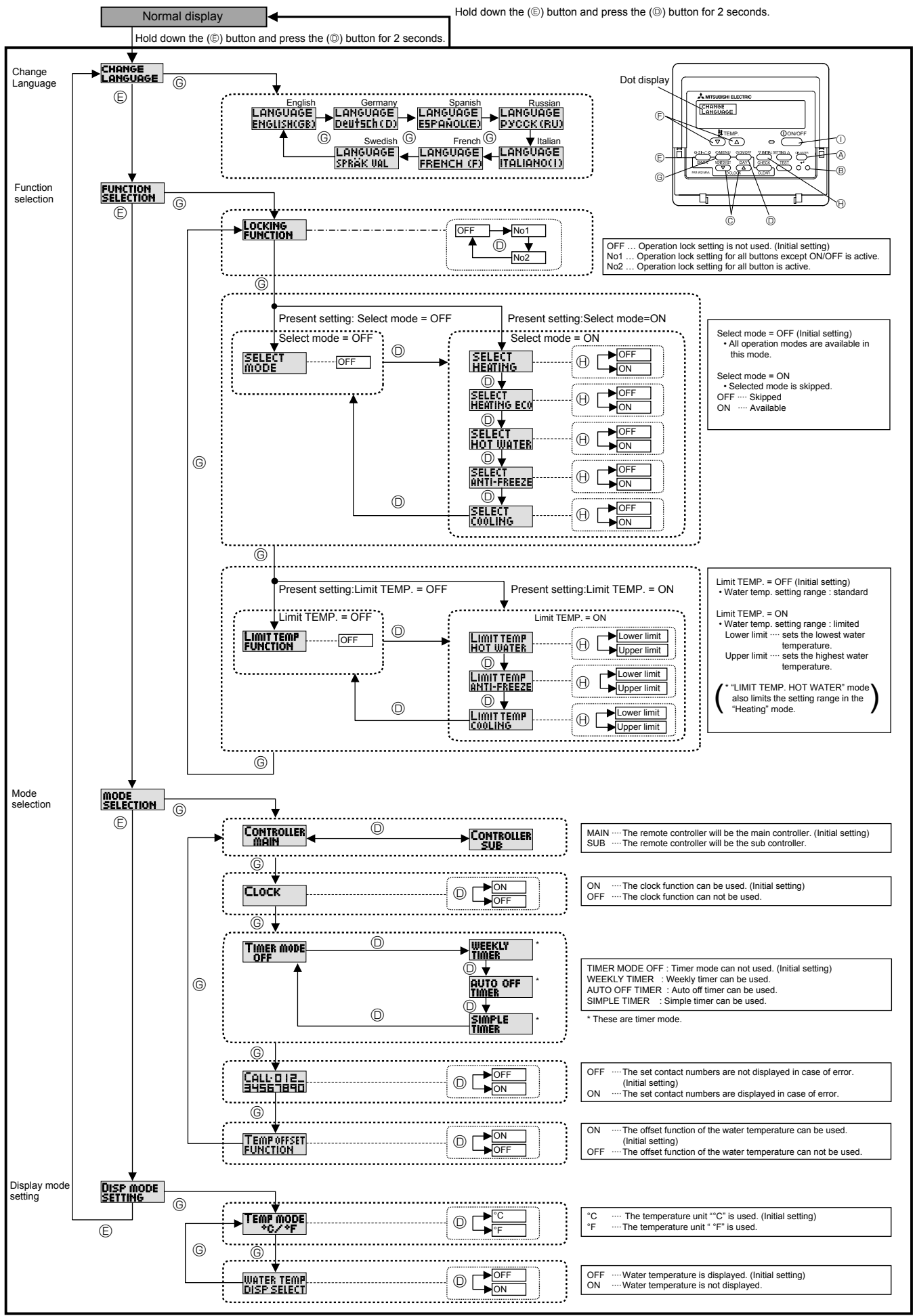

8. Remote controller operation

[Detailed setting]

[4]-1 CHANGE LANGUAGE setting

The language that appears on the dot display can be selected.

- Press the [⊖ MENU] button ⑥ to change the language.
 - ① English (GB), ② German (D), ③ Spanish (E), ④ Russian (RU),
 - ⑤ Italian (I), ⑥ French (F), ⑦ Swedish (SW)

Refer to the dot display table.

[4]-2 Function selection setting

(1) Operation function limit setting (operation lock)

- To switch the setting, press the [⊖ ON/OFF] button ⑩.
 - ① no1: Operation lock setting is made on all buttons other than the [⊖ ON/OFF] button ⑩.
 - ② no2: Operation lock setting is made on all buttons.
 - ③ OFF (Initial setting value): Operation lock setting is not made.
- * To make the operation lock setting valid on the normal screen, it is necessary to press buttons (Press and hold down the [CIR. WATER] ④ and [⊖ ON/OFF] buttons ⑩ at the same time for 2 seconds.) on the normal screen after the above setting is made.

(2) Use of operation mode setting

When the remote controller is connected to the unit that has the operation mode, the following settings can be made.

- To switch the setting, press the [⊖ ON/OFF] button ⑩.

① SELECT HEATING

ON: HEATING mode can be selected.

OFF: HEATING mode is skipped.

② SELECT HEATING ECO

ON: HEATING ECO mode can be selected.

OFF: HEATING ECO mode is skipped.

③ SELECT HOT WATER

ON: HOT WATER mode can be selected.

OFF: HOT WATER mode is skipped.

④ SELECT ANTI-FREEZE

ON: ANTI-FREEZE mode can be selected.

OFF: ANTI-FREEZE mode is skipped.

⑤ SELECT COOLING

ON: COOLING mode can be selected.

OFF: COOLING mode is skipped.

⑥ SELECT MODE OFF (Initial setting value)

The all operation mode is displayed when the mode is selected.

(3) Temperature range limit setting

After this setting is made, the temperature can be changed within the set range.

- To switch the setting, press the [⊖ ON/OFF] button ⑩.

① LIMIT TEMP HOT WATER MODE:

The temperature range can be changed on hot water / heating mode.

② LIMIT TEMP ANTI-FREEZE MODE:

The temperature range can be changed on anti-freeze mode.

③ LIMIT TEMP COOLING MODE:

The temperature range can be changed on cooling mode.

④ OFF (initial setting): The temperature range limit is not active.

* When the setting other than OFF is made, the temperature range limit setting on heating, hot water, anti-freeze, and cooling mode is made at the same time. However, the range cannot be limited when the set temperature range has not changed.

- To increase or decrease the temperature, press the [TEMP. (▽) or (△)] button ⑪.
- To switch the upper limit setting and the lower limit setting, press the [▽ INITIAL SETTING] button ⑫. The selected setting will blink and the temperature can be set.

[4]-3 Mode selection setting

(1) Remote controller main/sub setting

- To switch the setting, press the [⊖ ON/OFF] button ⑩.
 - ① Main: The controller will be the main controller.
 - ② Sub: The controller will be the sub controller.

(2) Use of clock setting

- To switch the setting, press the [⊖ ON/OFF] button ⑩.
 - ① ON: The clock function can be used.
 - ② OFF: The clock function cannot be used.

(3) Timer function setting

- To switch the setting, press the [⊖ ON/OFF] button ⑩ (Choose one of the followings.).
 - ① WEEKLY TIMER:
The weekly timer can be used.
 - ② AUTO OFF TIMER:
The auto off timer can be used.
 - ③ SIMPLE TIMER:
The simple timer can be used.
 - ④ TIMER MODE OFF (Initial setting):
The timer mode cannot be used.
- * When the use of clock setting is OFF, the "WEEKLY TIMER" cannot be used.

(4) Contact number setting for error situation

- To switch the setting, press the [⊖ ON/OFF] button ⑩.
 - ① CALL OFF:
The set contact numbers are not displayed in case of error.
 - ② CALL **** * ** *:
The set contact numbers are displayed in case of error.
CALL _:
The contact number can be set when the display is as shown above.
- Setting the contact numbers
To set the contact numbers, follow the following procedures.
Move the blinking cursor to set numbers. Press the [TEMP. (▽) and (△)] button ⑪ to move the cursor to the right (left). Press the [⊖ CLOCK (▽) and (△)] button ⑩ to set the numbers.

(5) Use of water temperature offset function

- To switch the setting, press the [⊖ ON/OFF] button ⑩.
 - ① ON: The water temperature offset function can be used.
 - ② OFF: The water temperature offset function cannot be used.
- * Refer to section 9 for details of offset function.

[4]-4 Display change setting

(1) Temperature display °C/°F setting

- To switch the setting, press the [⊖ ON/OFF] button ⑩.
 - ① °C: The temperature unit °C is used.
 - ② °F: The temperature unit °F is used.

(2) Water temperature display setting

- To switch the setting, press the [⊖ ON/OFF] button ⑩.
 - ① ON: Water temperature is displayed.
 - ② OFF: Water temperature is not displayed.

8. Remote controller operation

[Dot display table]

Selecting language		English	German	Spanish	Russia	Italian	French	Swedish
Waiting for start-up		PLEASE WAIT	←	←	←	←	←	←
Operation mode	Heating	HEATING	HEIZEN	CALOR	НАГРЕВ	RISCALD.	CHAUFF.	VÄRME DRIFT
	Heating ECO	HEATING ECO	HEIZEN ECO	CALOR ECO	НАГРЕВ ЭКОНОМ	RISCALD. ECO	CHAUFF-AGE ECO	VÄRME ECO
	Hot water	HOT WATER	BRAUCH-H2O	AGUA CALIENTE	ГОРЯЧАЯ ВОДА	ACQUA C. SANIT.	EAU CHAUDE	VÄRM VATTEN
	Anti-freeze	ANTI-FREEZE	FROSTSCHUTZ	ANTI-KONGEL.	АНТИ-ФРИЗ	ANTI GELO	ANTI GIVRE	FRYS SKYDD
	Cooling	COOLING	KÜHLEN	FRIO	ОХЛАЖАЕНИЕ	RAFFRED.	FROID	KYL DRIFT
	Stand by (Hot adjust) Defrost	STAND BY	STAND BY	CALENTANDO	ОБОГРЕВ ПАУЗА	STAND BY	PRE CHAUFFAGE	STAND BY
Not use button		NOT AVAILABLE	Nicht Verfügbar	NO DISPONIBLE	НЕ ДОСТУПНО	NON DISPONIBILE	NON DISPONIBLE	FINNS EJ
Check (Error)		CHECK	Prüfen	COMPROBAR	ПРОВЕРКА	CHECK	CONTROLE	CHECK
Test run		TEST RUN	Testbetrieb	TEST FUNCIONAMIENTO	ТЕСТОВЫЙ ЗАПУСК	TEST RUN	TEST	TEST LÄGE
Self check		SELF CHECK	Selbst-diagnose	AUTO REVISIÓN	САМОДИАГНОСТИКА	SELF CHECK	AUTO CONTROLE	SJÄLV CHECK
Change language		CHANGE LANGUAGE	←	←	←	←	←	←
Language selection		LANGUAGE ENGLISH(GB)	LANGUAGE DEUTSCH(D)	LANGUAGE ESPAÑOL(E)	LANGUAGE РУССКОЕ(RU)	LANGUAGE ITALIANO(I)	LANGUAGE FRENCH (F)	LANGUAGE SVEKAL(SV)
Display change		DISP MODE SETTING	Anzeige Betriebsart	MOstrar MODO	НАСТРОЙКА МЕНЮ	IMPOSTAZIONE MODO DISPLAY	AFFICHAGE SOUS MENU	DISPLAY LÄGE VAL
Temperature display °C/°F setting		TEMP MODE °C/°F	Wechsel °C/°F	TEMPGRADOS °C/°F	ЕДИН.ТЕМП. °C/°F	TEMPERATURA °C/°F	TEMPERATURE °C/°F	VAL AV TEMP MODE °C/°F
Water temperature display setting		WATER TEMP DISP SELECT	H2O-TEMP. DISP WAHL	VISUALIZAR TEMP. AGUA	ИНАДИКАЦИЯ ТЕМП. ВОДЫ	VISUALIZZA TEMP. ACQUA	AFFICHAGE TEMP EAU	VATTEN TEMP DISPLAYVAL
Function selection		FUNCTION SELECTION	Funktion auswählen	SELECCIÓN DE FUNCIONES	ВЫБОР ФУНКЦИИ	SELEZIONE FUNZIONI	SELECTION FONCTIONS	DRIFT VAL
Operation function limit setting		LOCKING FUNCTION	Sperr - Funktion	FUNCION BLOQUEADA	ФУНКЦИЯ БЛОКИРОВКИ	BLOCCO FUNZIONI	BLOCAGE FONCTIONS	DRIFT LÄS

Selecting language		English	German	Spanish	Russian	Italian	French	Swedish
Mode skip setting		SELECT MODE	AUSWAHL BETRIEBSART	ELEGIR MODO	УДАЛИТЬ РЕЖИМ	PROIBIZIONE MODO	SELECTION MODE INACTIF	DRIFT MODE VAL
Mode skip	Heating	SELECT HEATING	AUSWAHL HEIZEN	ELEGIR MODO CALOR	УДАЛИТЬ НАГРЕВ	PROIBIZIONE RISCALD.	CHAUFFAGE INACTIF	VAL VÄRMEDRIFT
	Heating ECO	SELECT HEATING ECO	AUSWAHL HEIZEN-ECO	ELEGIR CALOR ECO	УДАЛИТЬ НАГРЕВ ЭКОНОМ	PROIBIZIONE RISCALD. ECO	CHAUFFAGE ECO INACTIF	VAL VÄRME ECO
	Hot water	SELECT HOT WATER	AUSWAHL BRAUCH-H2O	ELEGIR AGUA CALIEN.	УДАЛИТЬ ГОРЯЧ. ВОДА	PROIBIZIONE ACQUA SAN.	EAU CHAUDE INACTIVE	VAL VÄRMVATTEN
	Anti-freeze	SELECT ANTI-FREEZE	AUSWAHL FROSTSCHUTZ	ELEGIR ANTIKONGEL.	УДАЛИТЬ АНТИФРИЗ	PROIBIZIONE ANTIGELO	ANTI GIVRE INACTIF	VAL FRYSSKYDD
	Cooling	SELECT COOLING	AUSWAHL KÜHLEN	ELEGIR MODO FRIO	УДАЛИТЬ ОХЛАЖАЕНИЕ	PROIBIZIONE RAFFREDD.	FROID INACTIF	VAL KYLDRIFT
Temperature range limit setting		LIMIT TEMP FUNCTION	Limit Temp Funktion	LIMIT TEMP CONSIGNA	ОГРАНИЧЕНИЕ ТЕМПЕРАТ	LIMITAZIONE TEMPERATURA	LIMITATION TEMPERATURE	MIN MAX TEMP VAL
Temperature range limit setting mode	Hot water	LIMIT TEMP HOT WATER	LIMIT TEMP BRAUCH-H2O	TEMP LIMITE AGUA CALIEN.	ОГРАНИЧ. ТЕМП. ГОРЯЧ. ВОДА	LIMITE TEMP. ACQUA SAN.	LIMITE TEMP EAU CHAUDE	MAXTEMP VÄRMVATTEN
	Anti-freeze	LIMIT TEMP ANTI-FREEZE	LIMIT TEMP FROSTSCHUTZ	TEMP LIMITE ANTIKONGEL.	ОГРАНИЧ. ТЕМП. АНТИФРИЗ	LIMITE TEMP. ANTIGELO	LIMITE TEMP ANTI GIVRE	MINTEMP FRYSSKYDD
	Cooling	LIMIT TEMP COOLING	LIMIT TEMP KÜHLEN	TEMP LIMITE MODO FRIO	ОГРАНИЧ. ТЕМП. ОХЛАЖАЕНИЕ	LIMITE TEMP. RAFFREDD.	LIMITE TEMP EN FROID	MINTEMP KYLDRIFT
Mode selection		MODE SELECTION	Betriebsart wählen	SELECCIÓN DE MODO	ВЫБОР РЕЖИМА	SELEZIONE MODO	SELECTION DU MODE	LÄGE VAL
Remote controller setting MAIN		CONTROLLER MAIN	Haupt Controller	CONTROL PRINCIPAL	ОСНОВНОЙ ПУЛЬТ	CONTROLLO MAIN	TECOMMANDE MAITRE	MASTER STYR
Remote controller setting SUB		CONTROLLER SUB	Neben Controller	CONTROL SECUNDARIO	ДОПОЛНИТЕЛЬНЫЙ ПУЛЬТ	CONTROLLO SUB	TECOMMANDE ESCLAVE	SLAV STYR
Use of clock setting		CLOCK	Uhr	RELOJ	ЧАСЫ	OROLOGIO	AFFICHAGE HORLOGE	KLOCKA
Setting the day of the week and time		TIME SET +:ENTER	Uhr stellen +:einstellen	CONFIG RELOJ +:CONFIG	ЧАСЫ:УСТ. +:ВВОД	OROLOGIO +:ENTER	HORLOGE +:ENTRER	TIME SET +:ENTER
Contact number setting		CALL-D 12 3456 7890	CALL-D 12 3456 7890	CALL-D 12 3456 7890	CALL-D 12 3456 7890	CALL-D 12 3456 7890	CALL-D 12 3456 7890	RING: 344-455665
Temperature off set function		TEMP OFFSET FUNCTION	SET ΔT FUNCTION	AJUSTE TEMP DIFERENCIAL	ПОГРЕШНОСТЬ ИЗМЕРЕНИЯ	IMPOSTA OFFSET	REGLAGE DELTA EAU	TEMP DIFFERENS
Temperature off set function (Heating)		TEMP OFFSET HEATING	SET ΔT HEIZEN	DIFERENCIAL MODO CALOR	ПОГРЕШНОСТЬ НАГРЕВ	OFFSET ACQUA RISCALD.	EN MODE CHAUD	TEMP DIFFERENS VÄRME
Temperature off set function (Cooling)		TEMP OFFSET COOLING	SET ΔT KÜHLEN	DIFERENCIAL MODO FRIO	ПОГРЕШНОСТЬ ОХЛАЖАЕНИЯ	OFFSET ACQUA RAFFREDD.	EN MODE FROID	TEMP DIFFERENS KYLA
Timer set		TIMER SET +:ENTER	Zeitschaltuhr +:einstellen	TEMPORIZA - DOR +:CONFIG	ТАЙМЕР:УСТ. +:ВВОД	TIMER +:ENTER	PROG HORAIRE +:ENTRER	TIMER SET +:ENTER
Timer monitor		TIMER MONITOR	Uhrzeit Anzeige	VISUALIZAR TEMPORIZAD.	ПРОСМОТР ТАЙМЕРА	VISUALIZ TIMER	AFFICHAGE PROG HORAIRE	TIMER MONITOR
Timer mode off		TIMER MODE OFF	Zeitschaltuhr AUS	TEMPORIZA - DOR APAGADO	ТАЙМЕР ВЫКЛ.	TIMER OFF	PROG HORAIRE INACTIF	TIMER LÄGE AV
Weekly timer		WEEKLY TIMER	Wochenzeit schalt Uhr	TEMPORIZA - DOR SEMANAL	НЕДЕЛЬНЫЙ ТАЙМЕР	TIMER SETTIMANALE	PROG HEBDO MADSAIRE	VECKOJ TIMER
Simple timer		SIMPLE TIMER	Einfache Zeitfunktion	TEMPORIZA - DOR SIMPLE	ПРОСТОЙ ТАЙМЕР	TIMER SEMPLIFICATO	PROG HORAIRE SIMPLIFIE	ENKEL TIMER

8. Remote controller operation

[Dot display table]

Selecting language	English	German	Spanish	Russian	Italian	French	Swedish	
Auto off timer	AUTO OFF TIMER	AUTO Zeit funktion AUS	APAGADO AUTOMÁTICO	АВТООТКЛЮЧ. ПО ТАЙМЕРУ	AUTO OFF TIMER	PROG HORNAIRE ARRÊT AUTO	AUTO TIMER AV	
Collective setting	COLLECTIVELY SETTING	COLLECTIVELY SETTING	COLLECTIVELY SETTING	COLLECTIVELY SETTING	COLLECTIVELY SETTING	COLLECTIVELY SETTING	KOLEKTIV VAL	
Water temperature (Initial setting)	Heating	WATER TEMP HEATING	SOLLWERT HEIZEN	TEMP. AGUA MODO CALOR	Т° ВОДА: НАГРЕВ	TEMP.AQUA RISCALD.	TEMP EAU CHAUFFAGE	BÖRVARDE VÄRMEDRIFT
	Heating ECO	WATER TEMP HEATING ECO	SOLLWERT HEIZEN-ECO	TEMP. AGUA CALOR ECO	Т° ВОДА: НАГРЕВ ЭКО	TEMP.AQUA RISCALD.ECO	TEMP EAU CHAUDE ECO	BÖRVARDE VÄRME ECO
	Hot water	WATER TEMP HOT WATER	SOLLWERT BRAUCH-H2O	TEMP. AGUA AGUA CALIEN.	Т° ВОДА: ГОРЯЧ. ВОДА	TEMP.AQUA SANITARIA	REGLAGETEMP EAU CHAUDE	BÖRVARDE VÄRMVATTEN
	Anti-freeze	WATER TEMP ANTI-FREEZE	SOLLWERT FROSTSCHUTZ	TEMP. AGUA ANTICONGEL.	Т° ВОДА: АНТИФРИЗ	TEMP.AQUA ANTIGELO	TEMP ANTI GIVRE	BÖRVARDE FRYSSKYDD
	Cooling	WATER TEMP COOLING	SOLLWERT KALT-H2O	TEMP. AGUA MODO FRIO	Т° ВОДА: ОХЛАЖДЕНИЕ	TEMP.AQUA RAFFREDD.	TEMP EAU EN FROID	BÖRVARDE KYLDRIKT
Option setting (Heating)	AD INPUT HEATING	AD-EINGANG HEIZEN	ENTRADA AD MODO CALOR	ДИАПАЗОН Т° НАГРЕВ	INPUT TEMP. RISCALD.	SIGNAL ENTREE EN CHAUD	KONFIGURE VÄRMEDRIFT	
Option setting (Cooling)	AD INPUT COOLING	AD-EINGANG KÜHLEN	ENTRADA AD MODO FRIO	ДИАПАЗОН Т° ОХЛАЖДЕНИЕ	INPUT TEMP. RAFFREDD.	SIGNAL ENTREE EN FROID	KONFIGURE KYLDRIKT	
Water circuit check	Check Water Circuit	PRÜFE HEZ-KREIS	COMPROBAR CIRCUIT. AGUA	ПРОВЕРЬТЕ КОНТУР ВОДА	VERIFICARE CIRC.AQUA	CONTROLE FILTRE A EAU	VÄTTFILTER CHECK	
Waiting for response	LOADING...	LADEN...	CARGANDO	ЗАГРУЗКА НАСТРОЕК...	LOADING...	CHARGEMENT	BEKRÄFTAR	
Waiting for setting	SETTING	EINSTELLUNG	AJUSTES	ОТПРАВКА НАСТРОЕК	SETTING...	REGLAGE	KONFIGURE	
Not dealt with	NOT AVAIL	NOT AVAIL	NOT AVAIL	NOT AVAIL	NOT AVAIL	NOT AVAIL	NOT AVAIL	
Maintenance	MAINTENANCE	MAINTENANCE	MAINTENANCE	MAINTENANCE	MAINTENANCE	MAINTENANCE	MAINTENANCE	

9. Initial setting by remote controller

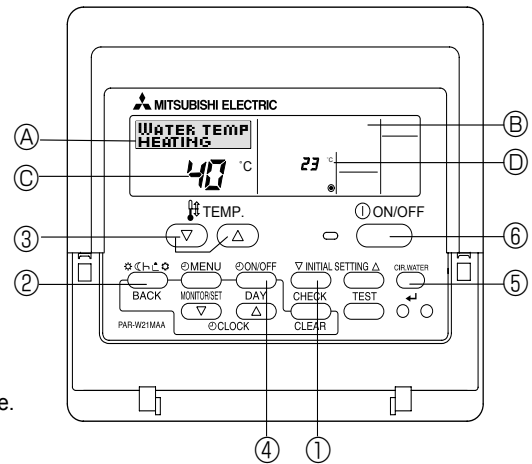

(1) Press the **INITIAL SETTING** button ① for 3 seconds to activate the initial setting mode.

(2) [DISPLAY ④]

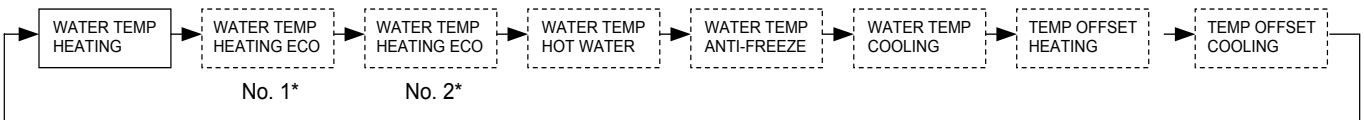

* No.1 or No.2 is indicated in display ④.

Press **MODE** button ② to switch to the next parameter setting.

<Target temperature in Heating mode>

WATER TEMP HEATING Set target flow water temperature in Heating mode with [TEMP] buttons (▼ and ▲) ③.

<Parameters for Heating ECO mode>

Set following 4 parameters in HEATING ECO mode with [TEMP] buttons (▼ and ▲) ③.
HEATING ECO mode = Weather compensation mode
Target flow water temperature varies according to the outdoor temperature.

WATER TEMP HEATING ECO No. 1 Display ④ shows target flow temperature.
Display ⑤ shows outdoor temperature.

WATER TEMP HEATING ECO No. 2 Display ④ shows target flow temperature.
Display ⑤ shows outdoor temperature.

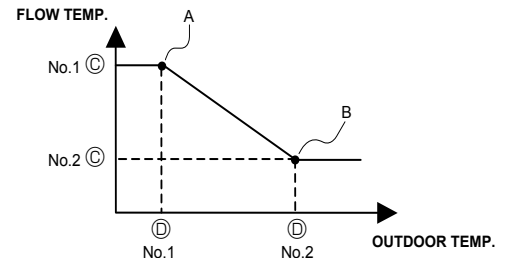

Press **ON/OFF** button ④ to switch ④ ↔ ⑤ alternately. (The blinking figure can be changed.)

Note:

- Heating ECO mode sets the set temperature depending on the outdoor temperature.
- The parameters except the above 4 parameters cannot be set. (The characteristic is linear between the point A and B.)
- When the "EXTERNAL INPUT (analog signal)" is used, the "HEATING ECO MODE" is invalid.

<Target temperature in HOT WATER mode>

WATER TEMP HOT WATER Set target flow water temperature in HOT WATER mode with [TEMP] buttons (▼ and ▲) ③.

<Target temperature in ANTI-FREEZE mode>

WATER TEMP ANTI-FREEZE Set target flow water temperature in ANTI-FREEZE mode with [TEMP] buttons (▼ and ▲) ③.

<Target temperature in COOLING mode>

WATER TEMP COOLING Set target flow water temperature in COOLING mode with [TEMP] buttons (▼ and ▲) ③.

9. Initial setting by remote controller

<Temperature OFFSET setting>

This setting is to adjust the difference between the actual temperature and the temperature sensed by the thermistor (TH1 or TH5) which tends to be lower due to heat leakage or something.

TEMP OFFSET HEATING (temperature offset setting for Domestic Hot Water)

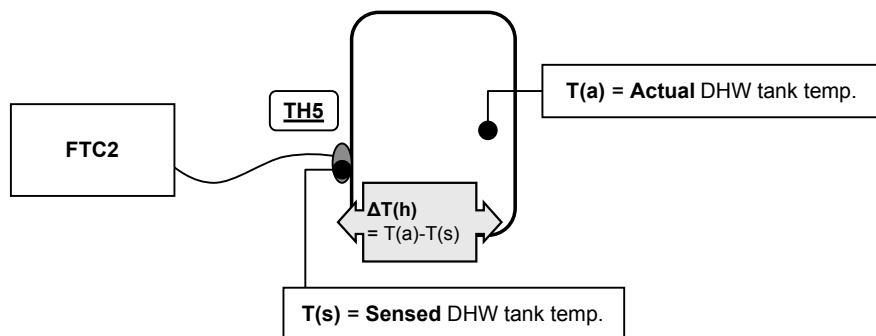

TEMP OFFSET HEATING

Set OFFSET temperature $\Delta T(h)$ in Domestic Hot Water mode with [TEMP] buttons (∇ and Δ) ③.

TEMP OFFSET COOLING (temperature offset setting for Cooling)

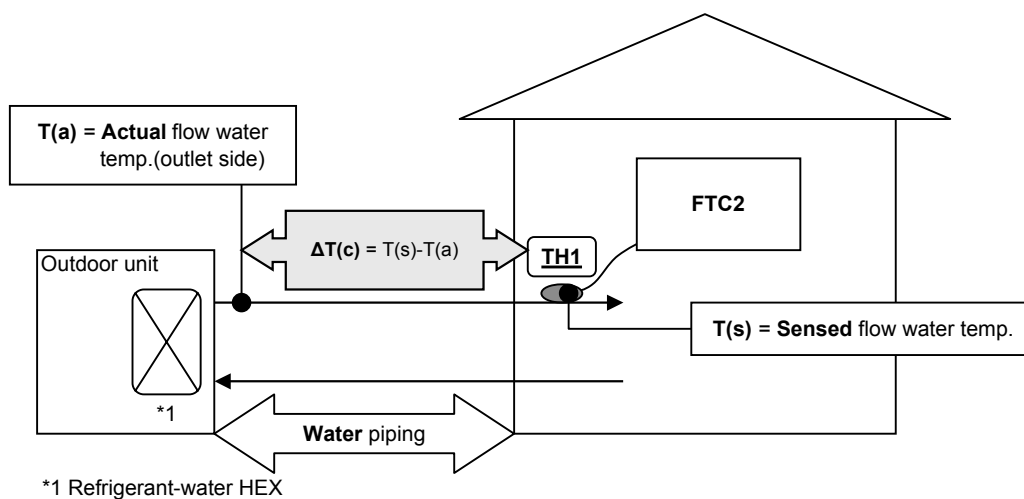

TEMP OFFSET COOLING

Set OFFSET temperature $\Delta T(c)$ in Cooling mode with [TEMP] buttons (∇ and Δ) ③.

※ OFFSET setting is not available in Heating mode.

◆ In order to let the PCB memorize the changed parameters

Make sure to press the **CIR.WATER** button ⑤ before quitting the INITIAL SETTING mode.

If you press the **ON/OFF** button ⑥ in INITIAL SETTING mode before pressing the **CIR.WATER** button ⑤, you can exit from this mode without any change.

10. Definition of analog signal by remote controller (Required only for ANALOG TEMP. system)

Set following 2 parameters to assign the target temperature value to analog signal figures.

(1) Press **INITIAL SETTING** button ① for 3 seconds to activate this setting mode.

(2) [DISPLAY ②]

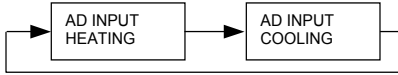

Press **MODE** button ② to switch to the next parameter setting.



Set flow temp. for No.1 and No.2 with [TEMP] buttons (**TEMP DOWN** and **TEMP UP**) ③.

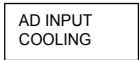

Set flow temp. for No.1 and No.2 with [TEMP] buttons (**TEMP DOWN** and **TEMP UP**) ③.

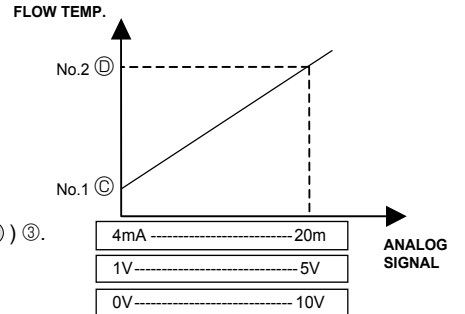

Press **ON/OFF** button ④ to switch ③ ↔ ④ alternately. (The blinking figure can be changed.)



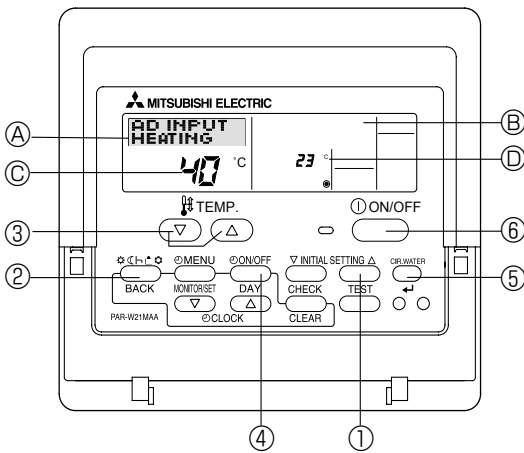

◆ In order to let FTC2 memorize set parameters

Make sure to press **CIR.WATER** button ⑤ before exit from ANALOG SIGNAL ADJUST mode.

If you press **ON/OFF** button ⑥ before pressing **CIR.WATER** button ⑤ in ADJUST mode, you can exit from this mode without making any change.



11. Troubleshooting

Water does not heat or cool well.	<ul style="list-style-type: none"> ■ Clean the filter of water piping. (Flow is reduced when the filter is dirty or clogged.) ■ Check the temperature adjustment and adjust the set temperature. ■ Make sure that there is plenty of space around the outdoor unit.
Water or vapor is emitted from the outdoor unit.	<ul style="list-style-type: none"> ■ During cooling mode, water may form and drip from the cool pipes and joints. ■ During heating mode, water may form and drip from the heat exchanger of outdoor unit. ■ During defrosting mode, water on the heat exchanger of outdoor unit evaporates and water vapor may be emitted.
The operation indicator does not appear in the remote controller display.	<ul style="list-style-type: none"> ■ Turn on the power switch. "●" will appear in the remote controller display.
"  appears in the remote controller display.	<ul style="list-style-type: none"> ■ During Analog input system, " appears in the remote controller display and FTC2 operation cannot be started or stopped using the remote controller. ■ During Legionella prevention mode, " appears in the remote controller display and FTC2 operation cannot be changed target flow temp. (Fixed in 60 °C or 65 °C).
When restarting the outdoor unit soon after stopping it, it does not operate even though the ON/OFF button is pressed.	<ul style="list-style-type: none"> ■ Wait approximately 3 minutes. (Operation has stopped to protect the outdoor unit.)
FTC2 operates without the ON/OFF button being pressed.	<ul style="list-style-type: none"> ■ Is the on timer set? Press the ON/OFF button to stop operation. ■ Is the FTC2 connected to an external signal? The FTC2 is being controlled by an external signal; check the source of the external signal. ■ Does " appear in the remote controller display? The FTC2 is being controlled by an external signal; check the source of the external signal. ■ Has the auto recovery feature from power failures been set? Press the ON/OFF button to stop operation.
FTC2 stops without the ON/OFF button being pressed.	<ul style="list-style-type: none"> ■ Is the off timer set? Press the ON/OFF button to restart operation. ■ Is the FTC2 connected to an external signal? The FTC2 is being controlled by an external signal; check the source of the external signal. ■ Does " appear in the remote controller display? The FTC2 is being controlled by an external signal; check the source of the external signal.
Remote controller timer operation cannot be set.	<ul style="list-style-type: none"> ■ Are timer settings invalid? If the timer can be set, WEEKLY , SIMPLE , or AUTO OFF appears in the remote controller display.
"PLEASE WAIT" appears in the remote controller display.	<ul style="list-style-type: none"> ■ The initial settings are being performed. Wait approximately 3 minutes. ■ If the remote controller is not only for FTC2, change it.
An error code appears in the remote controller display.	<ul style="list-style-type: none"> ■ The protection devices have operated to protect the FTC2 and outdoor unit. ■ Do not attempt to repair this equipment by yourself. Turn off the power switch immediately and consult your dealer. Be sure to provide the dealer with the model name and information that appeared in the remote controller display.
LED4 on FTC2 controller is lit.	<ul style="list-style-type: none"> ■ Is Flow switch that is connected to IN3 (TB142, 5-6) operating? Check the Flow switch. ■ Check the setting of Dip switch SW 3-6. Set the logic of open/short correctly.
LED5 on FTC2 controller is lit.	<ul style="list-style-type: none"> ■ Are TH1 and TH5 connected correctly? LED5 is lit if TH1 and TH5 are connected incorrectly and the temperature does not change. ■ Is 3-port valve installed correctly? LED5 is lit if 3-port valve is installed conversely and the temperature of TH1 and TH5 do not change.
LED5 on FTC2 controller is blinking.	<ul style="list-style-type: none"> ■ Is 3-port valve installed correctly? LED5 blinks if 3-port valve is installed conversely and the temperature of TH1 and TH5 do not change.

Local application factors

- * This FTC2 is designed to connect Mr.Slim/Ecodan inverter outdoor unit of MITSUBISHI ELECTRIC to local systems. Please check the following when designing the local system.
- * MITSUBISHI ELECTRIC does not take any responsibility on the local system design.

Heat exchanger

(1) Withstanding pressure

Designed pressure of outdoor unit is 4.15 MPa. Following must be satisfied for burst pressure of connecting application.
Burst pressure: More than 12.45 MPa (3 times more than designed pressure)

(2) Performance

Secure the heat exchanger capacity which meets the following conditions. If the conditions are not met, it may result in malfunction caused by the protection operation or the outdoor unit may be turned off due to the operation of protection system.

1. Evaporate temperature is more than 4 °C in max. frequency operation under ^{*}1 the cooling rated conditions.
2. In case of hot water supply, condense temperature is less than 58°C in max. frequency operation with the outside temperature 7 °C D.B./6 °C W.B.

*1. Outdoor: 35 °C D.B./24 °C W.B.

(3) Heat exchanger internal capacity

Heat exchanger internal capacity must be within the capacity range shown below. If the heat exchanger below the minimum capacity is connected, it may result in the back flow of liquid or the failure of the compressor.

If the heat exchanger above the maximum capacity is connected, it may result in the deficiency in performance due to lack of refrigerant or overheating of the compressor.

Minimum capacity: $10 \times \text{Model capacity [cm}^3\text{]}$ / Maximum capacity: $30 \times \text{Model capacity [cm}^3\text{]}$

e.g. When connecting to PUHZ-HRP100 VHA

Minimum capacity : $10 \times 100 = 1000 \text{ cm}^3$

Maximum capacity : $30 \times 100 = 3000 \text{ cm}^3$

Model capacity	35	50	60	71	100	125	140	200	250
Maximum capacity [cm ³]	1050	1500	1800	2130	3000	3750	4200	6000	7500
Minimum capacity [cm ³]	350	500	600	710	1000	1250	1400	2000	2500

(4) Contamination maintenance

1. Wash the inside of heat exchanger to keep it clean. Be sure to RINCE not to leave flux. Do not use chlorine detergent when washing.
2. Be sure that the amount of contamination per unit cubic content of heat transfer pipe is less than the following amount.

Example) In case of $\phi 9.52 \text{ mm}$

Residual water: 0.6 mg/m, Residual oil: 0.5 mg/m, Solid foreign object: 1.8 mg/m

Thermistor position

Refer to 4.4.

Note

- Install the hydraulic filter at the water intake.
- Use the inlet water of higher than 5 °C and lower than 55 °C.
- The water in a system should be clean and with pH value of 6.5-8.0.
- The followings are the maximum values;
 - Calcium: 100 mg/L
 - Chlorine: 100 mg/L
 - Iron/manganese: 0.5 mg/L
- Refrigerant pipe diameter from outdoor unit to refrigerant-water HEX (Only for SPLIT type)
Use the pipe with same diameter size as the refrigerant pipe connection diameter of outdoor unit. (Refer to outdoor unit installation manual.)
- Ensure that there is sufficient anti-freeze chemical in the water circuit. It is recommended to use 7 : 4 anti-freeze to water ratio.
The "5-6(IN3)" terminal on TB142 is for "Forced Comp. OFF" function as the EXTERNAL INPUT (Contact signal).
To input the abnormal signal of water pump or the abnormal lowering of water flow amount with non-voltage contact signal makes the outdoor unit stop forcibly. For details, refer to 4.3.1.
- The water velocity in pipes should be kept within certain limits of material to avoid erosion, corrosion and excessive noise generation.
Be aware, and take care of , that local velocities in small pipes, bends and similar obstructions can exceed the values above.
e.g.) Copper: 1.5m/s

⚠ Warning

- **Use clean enough water which meets water quality standards. The deterioration of water quality may result in the system breakdown or the water leakage.**
- **Never use anything other than water as a medium. It may cause a fire or an explosion.**
- **Do not use heated or cooled water that is produced by the air to water heat pump directly for drinking or cooking. There is a risk to damage your health. There is also a risk that installing the water heat exchanger may corrode if the necessary water quality for air to water heat pump system cannot be maintained. If you wish to use the heated or cooled water from the heated pump for these purposes, take measure such as to the second heat exchanger within the water piping system.**

This product is designed and intended for use in the residential,
commercial and light-industrial environment.

The product at hand is based on the following EU regulations:

- Low Voltage Directive 2006/95/EC
- Electromagnetic Compatibility Directive 2004/108/EC



 **MITSUBISHI ELECTRIC CORPORATION**

HEAD OFFICE: TOKYO BLDG., 2-7-3, MARUNOUCHI, CHIYODA-KU, TOKYO 100-8310, JAPAN

Authorised representative in EU: MITSUBISHI ELECTRIC EUROPE B.V.

HARMAN HOUSE, 1 GEORGE STREET, UXBRIDGE, MIDDLESEX UB8 1QQ, U.K.